

steuler | design

2024

PANARIAgroup®
Deutschland GmbH

FORMATE · FORMATS · INDEX

FEINSTEINZEUG PORCELAIN GRES GRÈS CÉRAME

7,2 × 7,2 cm

Gold Tiles 75

37,5 × 37,5 cm

Slate 124

30 × 60 cm

Belfort 67

60 × 60 cm

Belfort 67

Holmen neu · new · neuf 76

Homebase 84

Hygge 89

Kalmit 99

Milestone 115

Talo 127

37,5 × 75 cm

Limestone 112

Slate 124

75 × 75 cm

Limestone 112

Slate 124

60 × 90 cm

Belfort 67

20 × 90,5 cm

Lincoln 114

100 × 100 cm

Holmen neu · new · neuf 76

Kalmit neu · new · neuf 99

20 × 120 cm

Chalet 70

Feldberg 73

Sherwood neu · new · neuf 123

Talo 127

40 × 120 cm

Kalmit 99

60 × 120 cm

Holmen neu · new · neuf 77

Homebase 84

Hygge 89

Kalmit 99

Kollektion_M 107

Milestone 115

Talo 127

120 × 120 cm

Holmen neu · new · neuf 77

Hygge 89

Kalmit 99

Kollektion_M 107

Talo 127

25 × 150 cm

Sherwood neu · new · neuf 122

120 × 260 cm

Holmen neu · new · neuf 76

Hygge 88

Kalmit 98

Kollektion_M 106

Season 121

Talo 126

STEINGUT WALL TILE FAÏENCE

7,2 × 7,2 cm

Gold Tiles 23

30 × 60 cm

Brush 15

Kampen 24

Louis & Ella 2.0 27

Pure White 50

Pure White 52

Teardrop 40

Vanille 62

Varia 43

35 × 100 cm

Cameo 16

Marmor 33

Pure White 54

Sealine 34

Space Gem 36

Westerland 44

Wonderwall 46

40 × 120 cm

Arabesco 13

Frame 18

Maison 30

Pure White 58

Stavanger 38

SERIENINDEX · INDEX OF SERIES · INDEX DES SÉRIES

FEINSTEINZEUG

PORCELAIN GRÉS · GRÈS CÉRAMÉ

Belfort		67
Chalet		70
Feldberg		73
Gold Tiles		75
Holmen	neu · new · neuf	76
Homebase		84
Hygge		88
Kalmit		98
Kollektion_M		106
Limestone		112
Lincoln		114
Milestone		115
Season		121
Sherwood	neu · new · neuf	122
State		124
Talo		126

RUTSCHHEMMUNG

GRUNDFLIESE

SLIP-RESISTANCE OF PLAIN TILE

SÉCURITÉ DE DÉAMBULATION UNI

R10/B

Belfort		67
Chalet		70
Feldberg		73
Holmen	neu · new · neuf	76
Homebase		84
Hygge		88
Kalmit		98
Kollektion_M		106
Limestone		112
Lincoln		114
Milestone		115
Sherwood	neu · new · neuf	122
State		124
Talo		126

STEINGUT · WALL TILE · FAÏENCE

Arabesco	13
Brush	15
Cameo	16
Frame	18
Gold Tiles	23
Kampen	24
Louis & Ella 2.0	27
Maison	30
Marmor	33
Pure White	50
Sealine	34
Space Gem	36
Stavanger	38
Teardrop	40
Vanille	61
Varia	43
Westerland	44
Wonderwall	46

VIELFALT DES FARBSPIELS DER GRUNDFLIESE

COLOUR INTERPLAY OF PLAIN TILE

DIVERSITÉ DU JEU DE LUMIÈRE



Einfarbiges Produkt
Single-coloured product
Produit uni



Produkt mit leichtem Farbspiel
Product with slight colour interplay
Produit au léger jeu de lumière



Produkt mit ausgeprägtem Farbspiel
Product with distinct colour interplay
Produit au jeu de lumière marqué



Produkt mit starkem Farbspiel
Product with strong colour interplay
Produit au jeu de lumière prononcé

INHALT

CONTENT

SOMMAIRE

PROLOG · PROLOGUE	002
NEUHEITEN · NOVELTIES · NOUVEAUTÉS	006
KATALOG · CATALOG · CATALOGUE	011
INFORMATIONEN · INFORMATION · INFORMATIONS	135

2024

**FRISCH
UND
MODERN**

FRESH
AND MODERN

FRAÎCHE ET
MODERNE

Bei Steuler denken wir in Räumen – und die denken wir frisch und modern. Unsere maximale Leidenschaft für veredelte Keramik und extravagantes Design lässt uns außergewöhnliche Fliesen erschaffen, mit Liebe fürs Detail und dem Blick für die Wirkung im großen Kontext. Dabei kennen wir keine Grenzen bei Kreationen und Innovationen, sondern gehen gerne neue Wege hinsichtlich Farben, Formaten und Gestaltung. So entstehen unsere exklusiven Fliesen, im Design stets auf der Höhe der Zeit und qualitativ auf höchstem Niveau. Dieser Anspruch treibt uns immer wieder aufs Neue an – und wir haben noch viele Ideen.

At Steuler we think in terms of rooms - and what we think up is fresh and modern. Our all-out passion for finished ceramics and extravagant design means we can produce extraordinary tiles with attention to detail and an eye for the overall effect. Our creations and innovations know no bounds; instead we enjoy forging new paths in terms of colour, format and design. This is how our exclusive tiles are created; our designs always keep pace with the times and our quality is always at the highest level. This aspiration never ceases to drive us - and we have plenty more ideas.

Chez Steuler, nous pensons en termes d'espaces, de pièces à l'atmosphère fraîche et moderne. Notre grande passion pour la céramique à surface traitée et les designs extravagants engendre la création de carrelages hors du commun, avec beaucoup d'amour du détail et le coup d'œil pour l'effet créé dans un contexte plus large. Nous ne posons aucune limite à la création et à l'innovation et aimons emprunter des voies inexplorées concernant les couleurs, les formats et le design. C'est ainsi que nous créons nos carrelages exclusifs, au design toujours au goût du jour et d'une qualité du plus haut niveau. Cette exigence nous motive sans cesse et nous avons encore beaucoup d'idées en stock!

UNSER VERSPRECHEN



THIRD-PARTY VERIFIED
EPD
ISO 14025 and EN 15804



OUR PROMISE NOTRE PROMESSE

NACHHALTIGKEIT

Natürliche Schönheit

Es ist für uns eine Selbstverständlichkeit, höchste Qualität, zeitloses Design und aktiven Klimaschutz zu vereinen. Denn der Leitgedanke der Nachhaltigkeit ist für uns kein abstraktes Etikett – sondern eine konkrete Verpflichtung. Um ein deutliches Zeichen zu setzen, sind wir Mitglied bei IBU (Institut Bauen und Umwelt e. V.).

SUSTAINABILITY

Natural beauty

For us, combining premium quality timeless design and active climate protection is a matter of course. That's because, from our point of view, the principle of sustainability isn't an abstract label – it's a concrete commitment. To set a clear example, we are members of the IBU (Institute of Construction and Environment e. V.).

DURABILITÉ

Beauté naturelle

C'est pour nous une évidence d'allier niveau de qualité élevé, design intemporel et protection active du climat. Car l'idée maîtresse de la durabilité n'est pas, à nos yeux, une étiquette abstraite – il s'agit bien plus d'un engagement concret. Pour donner un exemple précis, nous faisons partie de l'IBU (Institut pour la construction et l'environnement e.V.).





**Einsatz von moderner Ablufttechnik,
geringer Schadstoffausstoß**

Use of modern exhaust-air technology,
low level of pollutant emissions

Utilisation d'une technologie moderne de
ventilation avec faibles rejets de matières
nocives

.....



**Abwasserfreier Produktionsablauf
durch Aufbereitung und Wasser aus dem
eigenen Werksbrunnen**

Wastewater-free production process
thanks to treatment, and water from our
own on-site well

Déroulement du processus de fabrication
sans production d'eaux usées grâce au
traitement intégral et à l'eau tirée de notre
propre puits

.....



**Zusammenarbeit mit ökologisch
zertifizierten Rohstofflieferanten und
sinnvolle Bruchwiederverwertung**

Collaboration with eco-certified suppliers
of raw materials and intelligent recycling of
broken material

Coopération avec des fournisseurs de
matières premières certifiés en matière
d'écologie et recyclage rationnel des rebuts

.....



Energieverbrauchssenkung

Reduction of energy consumption

Réduction de la consommation d'énergie



HOLMEN

120 x 278 cm · 120 x 120 cm · 100 x 100 cm · 60 x 120 cm · 60 x 60 cm

INNOVATIVE ARCHITEKTUR UND URBANES WOHNEN TREFFEN AUF ZEITLOSES DESIGN

„Holmen“ verbindet innovatives Design mit urbanem Lebensgefühl und ist in vier natürlichen Farbvarianten und verschiedenen Größen erhältlich. Inspiriert von der Architektur des Kopenhagener Stadtteils Holmen, fängt sie urbanes Flair ein und verleiht Räumen eine zeitgemäße Atmosphäre mit urbaner Raffinesse.

INNOVATIVE ARCHITECTURE AND URBAN LIVING MEET TIMELESS DESIGN

„Holmen“ combines innovative design with urban living feeling and is available in four natural color variations and various sizes. Inspired by the architecture of the Copenhagen district of Holmen, it encapsulates urban flair and gives rooms a contemporary atmosphere with urban sophistication.

UNE ARCHITECTURE INNOVANTE ET UNE VIE URBAINE RENCONTRENT UN DESIGN

„Holmen“ associe un design innovant à un sentiment de vie urbaine et est disponible en quatre variantes de couleurs naturelles et différents formats. Inspirée par l'architecture du quartier de Holmen à Copenhague, la série capture l'ambiance urbaine et confère aux espaces une atmosphère contemporaine avec une sophistication urbaine.



BODEN
FLOOR SOL

KATALOGSEITE 76
CATALOG PAGE 76
PAGE DU CATALOGUE 76

NEU
NEW · NEUF



FARBE · COLOUR · COLEUR
zement · cement · ciment



SHERWOOD

25 x 150 cm · 20 x 120 cm

„SHERWOOD“ IST ZEITLOS SCHÖN

Die Feinsteinzeug Serie „Sherwood“ ist eine Hommage an die Anmut über Jahrzehnte natürlich gewachsenen Holzes. Jede Fliese dieser Serie wurde sorgfältig gestaltet, um die einzigartige Maserung und die warme Ausstrahlung von Holz zu reproduzieren und dabei von den Vorteilen des Feinsteinzeugs zu profitieren. Mit den großzügigen und rektifizierten Dielenformaten 25x150 cm und 20x120 cm in den drei natürlichen Farbtönen Marone, Ginger und Sepia, erweckt die Serie „Sherwood“ nicht nur visuell, sondern auch olfaktorisch eine Ahnung von Waldluft - als käme sie direkt aus dem Herzen des Sherwood Forests.

„SHERWOOD“ IS TIMELESSLY BEAUTIFUL

The porcelain tile series „Sherwood“ is a tribute to the grace of naturally grown wood over decades. Each tile in this series has been carefully designed to replicate the unique grain and warm radiance of wood while benefiting from the advantages of porcelain. With broad and rectified plank formats of 25x150 cm and 20x120 cm in three natural shades - Maroon, Ginger, and Sepia - the „Sherwood“ series not only visually but also olfactorily evokes a sense of forest air, as if it were directly from the heart of the Sherwood Forest.

„SHERWOOD“ EST D'UNE BEAUTÉ INTEMPORELLE

La série de carreaux de grès cérame „Sherwood“ est un hommage à la grâce du bois naturellement formé au fil des décennies. Chaque carreau de cette série a été soigneusement conçu pour reproduire le grain unique et la chaleur du bois, tout en bénéficiant des avantages du grès cérame. Avec des formats de lames généreux et rectifiés de 25x150 cm et 20x120 cm dans trois teintes naturelles - Marron, Ginger et Sepia - la série „Sherwood“ évoque non seulement visuellement mais aussi olfactivement une sensation d'air de forêt, comme si elle venait directement du cœur de la forêt de Sherwood.



NEU
NEW · NEUF



FARBE · COLOUR · COLEUR
ginger

STEINGUT
WALL TILE
FAÏENCE

ARABESCO





40 × 120cm*

Y12320001 014 weiß glänzend · white glossy · blanc brillant

FORMAT FORMAT FORMAT	PREIS PRO PRICE PER PRIX PAR	STÜCK / M ² PIECES / M ² PIÈCES / M ²	KG / M ² KG / M ² KG / M ²	M ² / KARTON M ² / CARTON M ² / CARTON	STK / KARTON PCS / CARTON PCS / CARTON	KG / KARTON KG / CARTON KG / CARTON	M ² / PALETTE M ² / PALLET M ² / PALETTE	STK / PALETTE PCS / PALLET PCS / PALLETTE	KG / PALETTE KG / PALLET KG / PALLETTE
40 × 120 cm (1198 × 398 × 6 mm)	 M ²	2,0833	10,6250	1,9200	4	20,4000	46,0807	96	489,6000

BRUSH





30 × 60 cm

Y31000001 028 weiß matt · white mat · blanc mat



30 × 60 cm 

Y31010101 005 jade matt · jade mat

Flächendekor · Decorated plain tile · Uni décoré



30 × 60 cm

Y31005001 005 Run jade matt · jade mat



30 × 60 cm

Y31020001 005 maigrün matt · may green mat · vert mai mat



30 × 60 cm

Y31015001 005 Run maigrün matt · may green mat · vert mai mat



30 × 60 cm

Y31030001 005 nordisch blau matt · nordic blue mat · bleu nordique mat





30 × 60 cm 

Y31025101 005 Run nordisch blau matt · nordic blue mat · bleu nordique mat

Flächendekor · Decorated plain tile · Uni décoré



FORMAT FORMAT	PREIS PRO PRICE PER PRIX PAR	STÜCK / M ² PIECES / M ²	KG / M ² KG / M ²	M ² / KARTON M ² / CARTON	STK / KARTON PCS / CARTON	KG / KARTON KG / CARTON	M ² / PALETTE M ² / PALLET	STK / PALETTE PCS / PALLET	KG / PALETTE KG / PALLET
30 × 60 cm (598 × 298 × 6 mm)	 M ²	5,5556	10,0560	1,4400	8	14,4805	103,6720	576	1.042,5600
30 × 60 cm (598 × 298 × 6 mm)	 M ²	5,5556	11,4000	1,8000	10	19,0000	107,9991	600	1.140,0000

UMSTELLUNG
CONVERSION

Dazu passend · Suitable to · Sol coordonné:

MARBURG, NAGOLD Extra Preisblatt · Extra price sheet · Extra feuille

CAMEO

35 × 100



35 × 100 cm

Y15040001 021 beige matt · beige mat



35 × 100 cm

Y15041001 021 sand matt · sand mat · sable mat



35 × 100 cm

Y15043001 174 Flax kupfer matt · copper mat · cuivre mat

Dekor · Decor · Décor



30 × 30 cm

Y30118001 183

dark-sand · dark-sable

Mosaik · Mosaic · Mosaïque



geschnitten aus:

cut from tile:

découpe du carreau:

CAMPUS & PATCHWOOD



FORMAT FORMAT FORMAT	PREIS PRO PRICE PER PRIX PAR	STÜCK / M ² PIECES / M ² PIÈCES / M ²	KG / M ² KG / M ² KG / M ²	M ² / KARTON M ² / CARTON M ² / CARTON	STK / KARTON PCS / CARTON PCS / CARTON	KG / KARTON KG / CARTON KG / CARTON	M ² / PALETTE M ² / PALLET M ² / PALETTE	STK / PALETTE PCS / PALLET PCS / PALETTE	KG / PALETTE KG / PALLET KG / PALLETTE
35 × 100 cm (998 × 348 × 10,5 mm)	 M ²	2,8571	17,8570	1,0500	3	18,7501	27,3010	78	487,5000
35 × 100 cm (998 × 348 × 10,5 mm)	 STK · PCS	2,8571	17,8570	1,0500	3	18,7501	-	-	-
30 × 30 cm (298 × 298 × 9 mm)	 STK · PCS	11,1110	21,1110	0,4500	5	9,5000	-	-	-



30 × 30 cm

Y30123001 183

light-grau · light-grey · light-gris

Mosaik · Mosaic · Mosaïque

geschnitten aus:

cut from tile:

découpe du carreau:

CAMPUS & PATCHWOOD



35 × 100 cm

Y15045001 021 grau matt · grey mat · gris mat

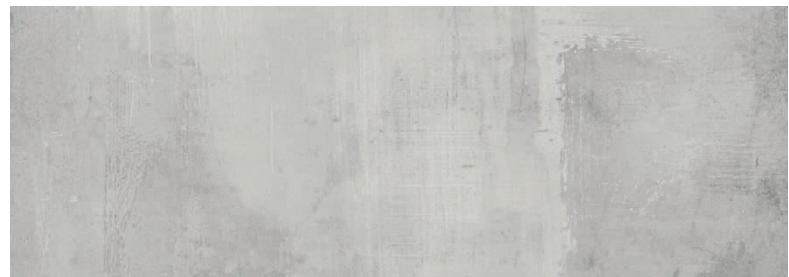

35 × 100 cm

Y15046001 021 zement matt · cement mat · ciment mat



35 × 100 cm

Y15048001 174 Flax silber matt · silver mat · argent mat

Dekor · Decor · Décor

FORMAT FORMAT FORMAT	PREIS PRO PRICE PER PRIX PAR	STÜCK / M ² PIECES / M ² PIÈCES / M ²	KG / M ² KG / M ² KG / M ²	M ² / KARTON M ² / CARTON M ² / CARTON	STK / KARTON PCS / CARTON PCS / CARTON	KG / KARTON KG / CARTON KG / CARTON	M ² / PALETTE M ² / PALLET M ² / PALETTE	STK / PALETTE PCS / PALLET PCS / PALLETTE	KG / PALETTE KG / PALLET KG / PALLETTE
35 × 100 cm (998 × 348 × 10,5 mm)	M ²	2,8571	17,8570	1,0500	3	18,7501	27,3010	78	487,5000
35 × 100 cm (998 × 348 × 10,5 mm)	STK · PCS	2,8571	17,8570	1,0500	3	18,7501	-	-	-
30 × 30 cm (298 × 298 × 9 mm)	STK · PCS	11,1110	21,1110	0,4500	5	9,5000	-	-	-

FRAME

40 × 120

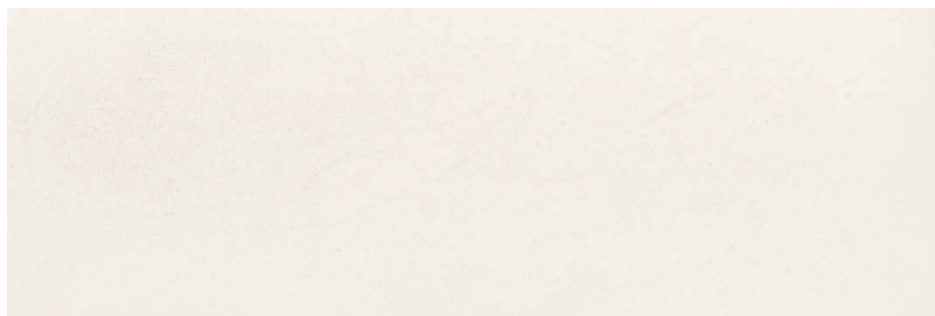

40 × 120 cm*

Y12330001 035 warm

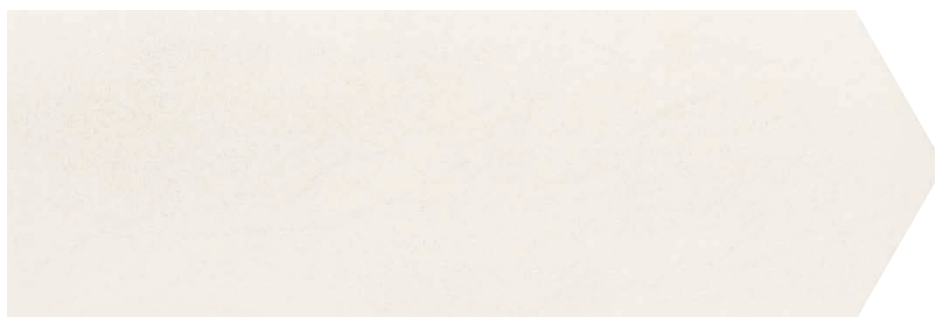

40 × 120 cm*



Y12331001 104 warm

Schnittdekor für Sixside

Cut decor for Sixside

Décor découpe pour Sixside



FORMAT FORMAT FORMAT	PREIS PRO PRICE PER PRIX PAR	STÜCK / M ² PIECES / M ² PIÈCES / M ²	KG / M ² KG / M ² KG / M ²	M ² / KARTON M ² / CARTON M ² / CARTON	STK / KARTON PCS / CARTON PCS / CARTON	KG / KARTON KG / CARTON KG / CARTON	M ² / PALETTE M ² / PALLET M ² / PALLETTE	STK / PALETTE PCS / PALLET PCS / PALLETTE	KG / PALETTE KG / PALLET KG / PALLETTE
40 × 120 cm (1198 × 398 × 6 mm)	 M ²	2,0833	10,6250	1,9200	4	20,4000	46,0807	96	489,6000
40 × 120 cm (1198 × 398 × 6 mm)	 STK · PCS	2,1816	10,5899	1,8275	4	19,4167	-	-	-



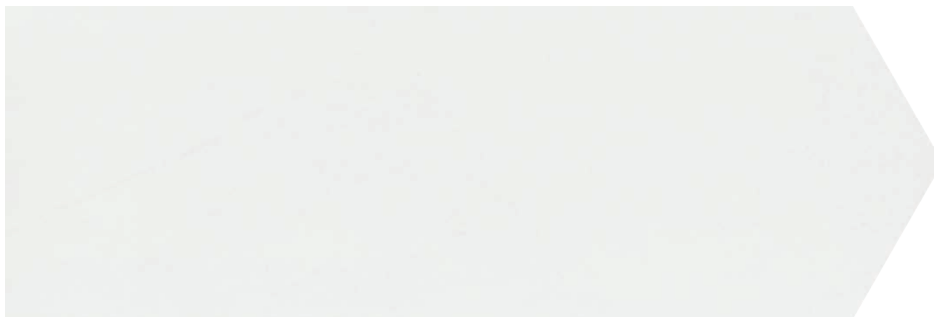

40 × 120 cm*
 Y12335001 035 cool



40 × 120 cm*
 Y12336001 104 cool

Schnittdekor für Sixside
 Cut decor for Sixside
 Décor découpe pour Sixside



FORMAT FORMAT FORMAT	PREIS PRO PRICE PER PRIX PAR	STÜCK / M ² PIECES / M ² PIÈCES / M ²	KG / M ² KG / M ² KG / M ²	M ² / KARTON M ² / CARTON M ² / CARTON	STK / KARTON PCS / CARTON PCS / CARTON	KG / KARTON KG / CARTON KG / CARTON	M ² / PALETTE M ² / PALLET M ² / PALLETTE	STK / PALETTE PCS / PALLET PCS / PALLETTE	KG / PALETTE KG / PALLET KG / PALLETTE
40 × 120 cm (1198 × 398 × 6 mm)	 M ²	2,0833	10,6250	1,9200	4	20,4000	46,0807	96	489,6000
40 × 120 cm (1198 × 398 × 6 mm)	 STK · PCS	2,1816	10,5899	1,8275	4	19,4167	-	-	-

FRAME

40 × 46

Steingut · Wall tile · Faïence
Rektifiziert · Rectified · Rectifié



40 × 46 cm* 
Y12345001 150 Frame warm
Sixside Dekor · Decor · Décor

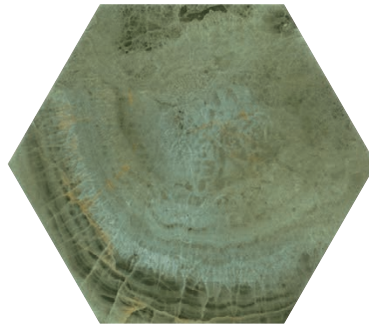

40 × 46 cm** 
Y12347001 158 field
Sixside Dekor · Decor · Décor

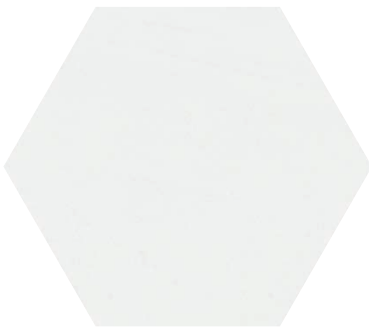
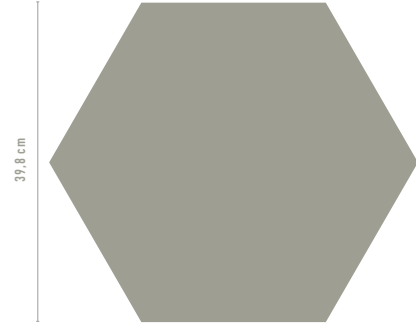

40 × 46 cm* 
Y12346001 150 Frame cool
Sixside Dekor · Decor · Décor

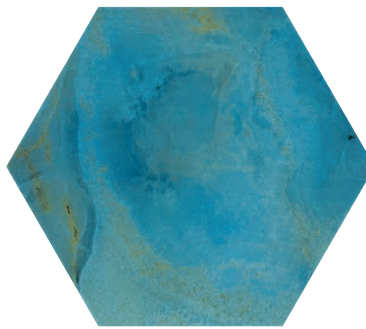



40 × 46 cm** 
Y12348001 158 lake
Sixside Dekor · Decor · Décor

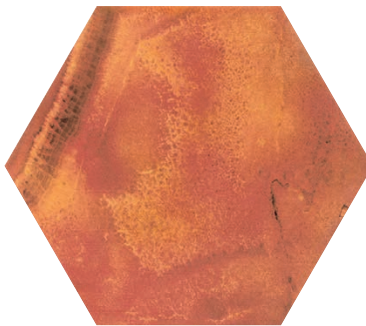

40 × 46 cm**   
Y12350001 190 Relief gold · or
Sixside Dekor · Decor · Décor



40 × 46 cm** 
Y12349001 158 earth
Sixside Dekor · Decor · Décor

FORMAT FORMAT	PREIS PRO PRICE PER PRIX PAR	STÜCK / M ² PIECES / M ² PIÈCES / M ²	KG / M ² KG / M ² KG / M ²	M ² / KARTON M ² / CARTON M ² / CARTON	STK / KARTON PCS / CARTON PCS / CARTON	KG / KARTON KG / CARTON KG / CARTON	M ² / PALETTE M ² / PALLET M ² / PALETTE	STK / PALETTE PCS / PALLET PCS / PALLETTE	KG / PALETTE KG / PALLET KG / PALLETTE
40 × 46 cm*	 STK · PCS	7,2990	10,9490	1,0960	8	12,0000	-	-	-
40 × 46 cm**	 STK · PCS	7,2990	10,2190	1,0960	8	11,2000	-	-	-



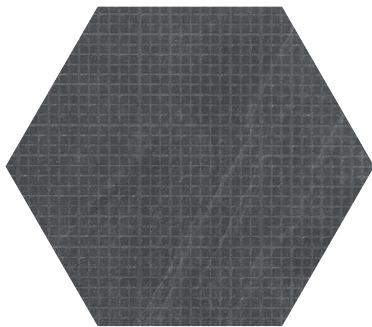

40 × 46 cm*
 Y12360001 122 diamond
 Sixside Dekor · Decor · Décor



40 × 46 cm**
 Y12363001 129 Hygge kiesel · pebble · galets
 Sixside Dekor · Decor · Décor



40 × 46 cm**
 Y12365001 129 Hygge clay
 Sixside Dekor · Decor · Décor

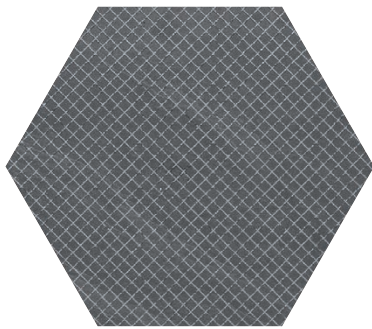

40 × 46 cm*
 Y12361001 122 square
 Sixside Dekor · Decor · Décor

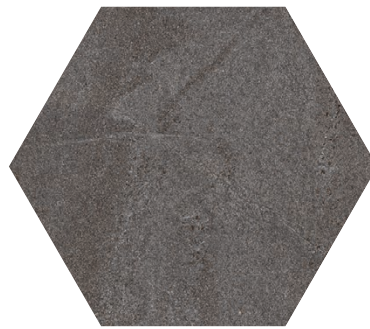

40 × 46 cm**
 Y12364001 129 Hygge lava
 Sixside Dekor · Decor · Décor

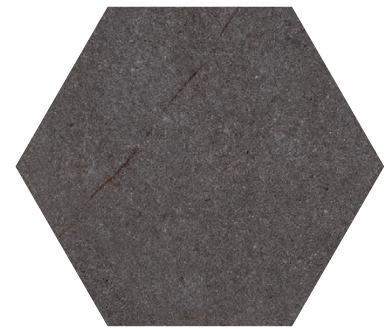

40 × 46 cm**
 Y12366001 129 Hygge basalt
 Sixside Dekor · Decor · Décor

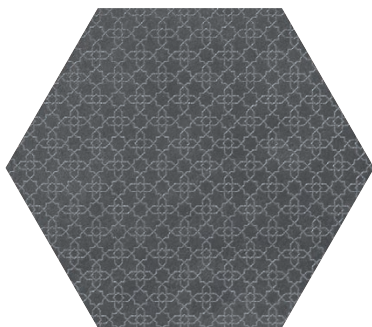

40 × 46 cm*
 Y12362001 122 mauresk
 Sixside Dekor · Decor · Décor

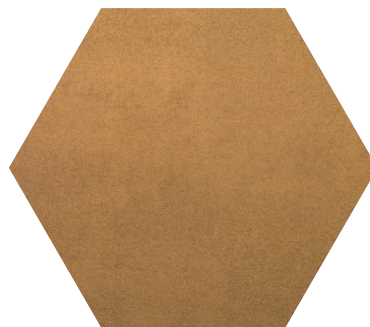

40 × 46 cm**
 Y12367001 190 gold · or
 Sixside Dekor · Decor · Décor

FORMAT FORMAT FORMAT	PREIS PRO PRICE PER PRIX PAR	STÜCK / M ² PIECES / M ² PIÈCES / M ²	KG / M ² KG / M ² KG / M ²	M ² / KARTON M ² / CARTON M ² / CARTON	STK / KARTON PCS / CARTON PCS / CARTON	KG / KARTON KG / CARTON KG / CARTON	M ² / PALETTE M ² / PALLET M ² / PALLETTE	STK / PALETTE PCS / PALLET PCS / PALLETTE	KG / PALETTE KG / PALLET KG / PALLETTE
40 × 46 cm*	STK · PCS	7,2990	14,5980	1,0960	8	16,0000	-	-	-
40 × 46 cm**	STK · PCS	7,2990	13,8680	1,0960	8	15,2000	-	-	-

GOLD TILES



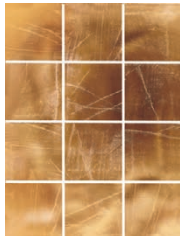

7,2 × 7,2 cm (22 × 30 cm)

Y35049001 049 realgold

Steingut · Wall tile · Faïence

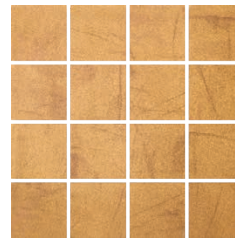

7,2 × 7,2 cm (30 × 30 cm)

Y65015001 099 realgold

Feinsteinzeug · Porcelain gres · Grès cérame

netzverklebt · glued on mesh-type net · collé sur maillage

Mosaik · Mosaic · Mosaïque

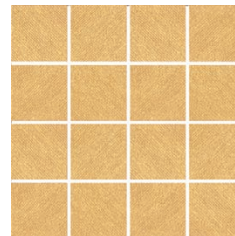

7,2 × 7,2 cm (30 × 30 cm)

Y65025001 099 Royal realgold

Feinsteinzeug · Porcelain gres · Grès cérame

netzverklebt · glued on mesh-type net · collé sur maillage

Mosaik · Mosaic · Mosaïque



FORMAT FORMAT FORMAT	PREIS PRO PRICE PER PRIX PAR	STÜCK / M ² PIECES / M ² PIÈCES / M ²	KG / M ² KG / M ² KG / M ²	M ² / KARTON M ² / CARTON M ² / CARTON	STK / KARTON PCS / CARTON PCS / CARTON	KG / KARTON KG / CARTON KG / CARTON	M ² / PALETTE M ² / PALLET M ² / PALETTE	STK / PALETTE PCS / PALLET PCS / PALLETTE	KG / PALETTE KG / PALLET KG / PALLETTE
7,2 × 7,2 cm (72 × 72 × 7 mm)	M ²	15,2200	12,2980	0,6570	10	8,0802	26,2810	400	323,2000
7,2 × 7,2 cm (72 × 72 × 8 mm)	M ²	11,0000	18,7000	1,0000	11	18,7000	48,0000	528	897,6000

KAMPEN

30 × 60



UMSTELLUNG
CONVERSION

30 × 60 cm 

Y32145101 * natur · natural · nature



30 × 60 cm

Y32150001 * sand · sable





30 × 60 cm

Y32151001 * Reet sand · sable

Dekor · Decor · Décor

UMSTELLUNG
CONVERSION

FORMAT FORMAT FORMAT	PREIS PRO PRICE PER PRIX PAR	STÜCK / M ² PIECES / M ² PIÈCES / M ²	KG / M ² KG / M ² KG / M ²	M ² / KARTON M ² / CARTON M ² / CARTON	STK / KARTON PCS / CARTON PCS / CARTON	KG / KARTON KG / CARTON KG / CARTON	M ² / PALETTE M ² / PALLET M ² / PALETTE	STK / PALETTE PCS / PALLET PCS / PALLETTE	KG / PALETTE KG / PALLET KG / PALLETTE
30 × 60 cm (598 × 298 × 6 mm)	 M ²	5,5556	10,5556	1,8000	10	19,0000	107,9991	600	1.140,0000
30 × 60 cm (598 × 298 × 6 mm)	 M ²	5,5556	10,0560	1,4400	8	14,4800	103,6792	576	1.042,5600
30 × 60 cm (598 × 298 × 6 mm)	 STK · PCS	5,5556	10,0560	1,8000	10	18,1000	-	-	-



UMSTELLUNG
 CONVERSION

30 × 60 cm 

Y32155101 * kalk · limestone · chaux



30 × 60 cm

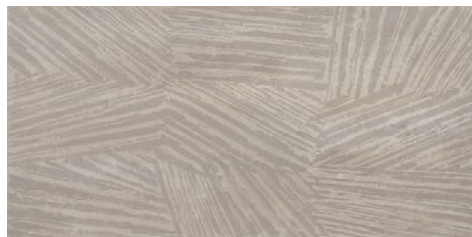

Y32160001 * stein · stone · pierre



30 × 60 cm

Y32161001 * Reet stein · stone · pierre

Dekor · Decor · Décor

FORMAT FORMAT FORMAT	PREIS PRO PRICE PER PRIX PAR	STÜCK / M ² PIECES / M ² PIÈCES / M ²	KG / M ² KG / M ² KG / M ²	M ² / KARTON M ² / CARTON M ² / CARTON	STK / KARTON PCS / CARTON PCS / CARTON	KG / KARTON KG / CARTON KG / CARTON	M ² / PALETTE M ² / PALLET M ² / PALETTE	STK / PALETTE PCS / PALLET PCS / PALLETTE	KG / PALETTE KG / PALLET KG / PALETTE
30 × 60 cm (598 × 298 × 6 mm)	 M ²	5,5556	10,5556	1,8000	10	19,0000	107,9991	600	1.140,0000
30 × 60 cm (598 × 298 × 6 mm)	 M ²	5,5556	10,0560	1,4400	8	14,4800	103,6792	576	1.042,5600
30 × 60 cm (598 × 298 × 6 mm)	 STK · PCS	5,5556	10,0560	1,8000	10	18,1000	-	-	-

* Siehe separates Preisblatt

Please see the separate price list · Voir la liste des prix séparée

LOUIS & ELLA 2.0





30 × 60 cm

Y30525001 019 weiß matt · white mat · blanc mat

Serie · Series · Série: VARIA



30 × 60 cm

Y30532001 101 Wolken · clouds · nuages

Dekor · Decor · Décor



30 × 60 cm

Y30533001 101 Graskante · grass border · herbe

Dekor · Decor · Décor



30 × 60 cm

Y30534001 101 Gras voll · grass · herbe

Dekor · Decor · Décor



30 × 60 cm

Y30535001 101 Graskante Zebra · grass border, zebra · herbe, zèbre

Dekor · Decor · Décor



30 × 60 cm

Y30537001 101 Giraffenbeine, Gras · giraffe legs, grass · jambes de girafe, herbe

Dekor · Decor · Décor

FORMAT FORMAT FORMAT	PREIS PRO PRICE PER PRIX PAR	STÜCK / M ² PIECES / M ² PIÈCES / M ²	KG / M ² KG / M ² KG / M ²	M ² / KARTON M ² / CARTON M ² / CARTON	STK / KARTON PCS / CARTON PCS / CARTON	KG / KARTON KG / CARTON KG / CARTON	M ² / PALETTE M ² / PALLET M ² / PALLETTE	STK / PALETTE PCS / PALLET PCS / PALLETTE	KG / PALETTE KG / PALLET KG / PALLETTE
30 × 60 cm (598 × 298 × 8 mm)	M ²	5,5556	13,1110	1,4400	8	18,8797	86,3930	480	1.132,8000
30 × 60 cm (598 × 298 × 8 mm)	STK · PCS	5,5556	13,1110	1,0800	6	14,1598	-	-	-

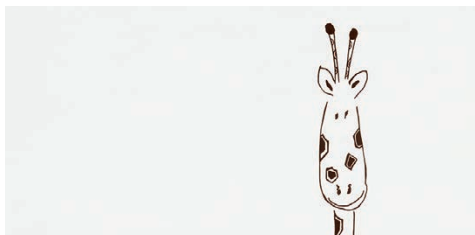

30 × 60 cm

Y30538001 101

Giraffenkopf gerade · giraffe head · tête de girafe

Dekor · Decor · Décor

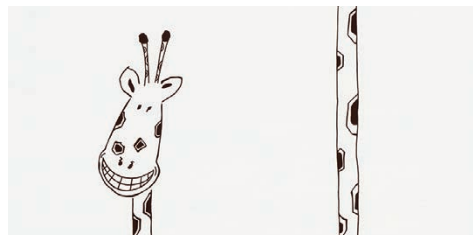

30 × 60 cm

Y30543001 101

Hals & Kopf · neck & head · cou & tête

Dekor · Decor · Décor



30 × 60 cm

Y30540001 101

Giraffenhals · giraffe neck · cou de girafe

Dekor · Decor · Décor



30 × 60 cm

Y30544001 101

2 Giraffenhälse · 2 giraffe necks · 2 cous de girafe

Dekor · Decor · Décor



30 × 60 cm

Y30541001 101

Giraffenkörper · giraffe body · corps de girafe

Dekor · Decor · Décor



30 × 60 cm

Y30545001 101

2 Giraffenkörper · 2 giraffe bodies · 2 corps de girafe

Dekor · Decor · Décor



30 × 60 cm

Y30542001 101

Giraffenbeine · giraffe legs · jambes de girafe

Dekor · Decor · Décor



30 × 60 cm

Y30546001 101

Giraffenbeine 2er · legs of 2 giraffes · jambes de 2 girafes

Dekor · Decor · Décor

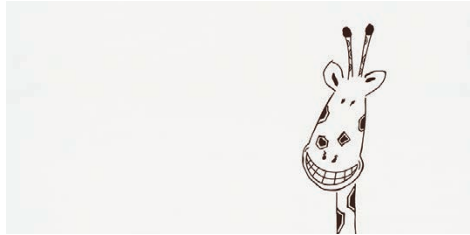

30 × 60 cm

Y30539001 101

Giraffenkopf lachend · smiling giraffe · tête de girafe, souriante

Dekor · Decor · Décor

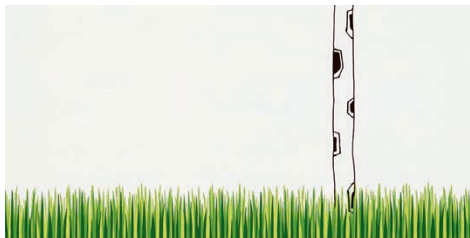

30 × 60 cm

Y30536001 101

Giraffenhals Gras · giraffe neck, grass · cou de girafe, herbe

Dekor · Decor · Décor

FORMAT FORMAT FORMAT	PREIS PRO PRICE PER PRIX PAR	STÜCK / M ² PIECES / M ² PIÈCES / M ²	KG / M ² KG / M ² KG / M ²	M ² / KARTON M ² / CARTON M ² / CARTON	STK / KARTON PCS / CARTON PCS / CARTON	KG / KARTON KG / CARTON KG / CARTON	M ² / PALETTE M ² / PALLET M ² / PALETTE	STK / PALETTE PCS / PALLET PCS / PALLETTE	KG / PALETTE KG / PALLET KG / PALLETTE
30 × 60 cm (598 × 298 × 8 mm)	 STK · PCS	5,5556	13,1110	1,0800	6	14,1598	-	-	-

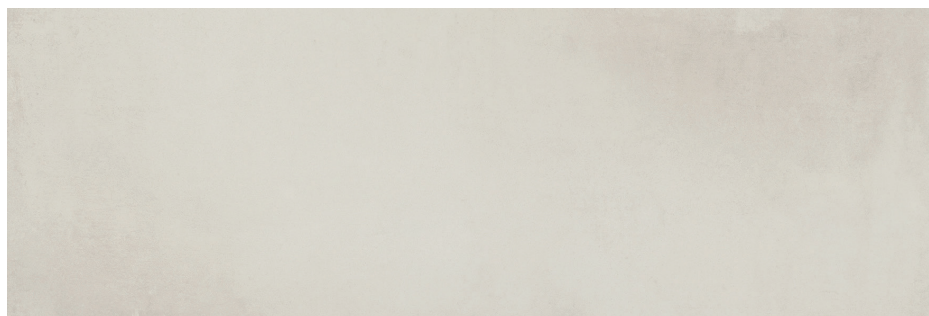

40 × 120 cm*

Y12090001 018 creme · cream · crème

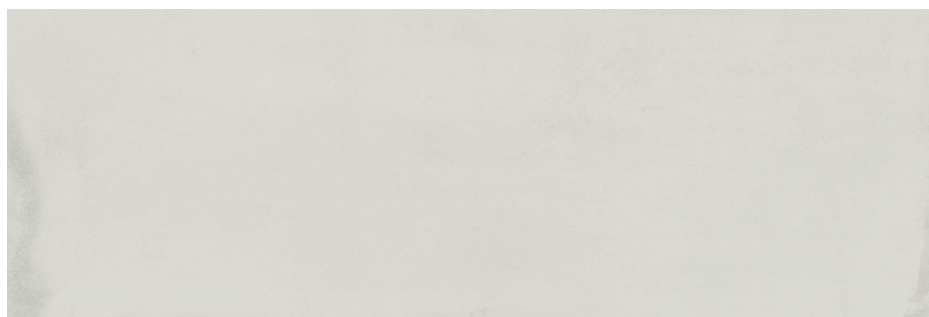

40 × 120 cm*

Y12095001 018 kreide · chalk · craie

FORMAT FORMAT FORMAT	PREIS PRO PRICE PER PRIX PAR	STÜCK / M ² PIECES / M ² PIÈCES / M ²	KG / M ² KG / M ² KG / M ²	M ² / KARTON M ² / CARTON M ² / CARTON	STK / KARTON PCS / CARTON PCS / CARTON	KG / KARTON KG / CARTON KG / CARTON	M ² / PALETTE M ² / PALLET M ² / PALETTE	STK / PALETTE PCS / PALLET PCS / PALETTE	KG / PALETTE KG / PALLET KG / PALETTE
40 × 120 cm (1198 × 398 × 6 mm)	 M ²	2,0833	10,6250	1,9200	4	20,4000	46,0807	96	489,6000



40 × 120 cm*
 Y12100001 018 sand · sable



40 × 120 cm*
 Y12105001 018 terracotta · terre cuite



40 × 120 cm*
 Y12110001 018 blu

FORMAT FORMAT FORMAT	PREIS PRO PRICE PER PRIX PAR	STÜCK / M ² PIECES / M ² PIÈCES / M ²	KG / M ² KG / M ² KG / M ²	M ² / KARTON M ² / CARTON M ² / CARTON	STK / KARTON PCS / CARTON PCS / CARTON	KG / KARTON KG / CARTON KG / CARTON	M ² / PALETTE M ² / PALLET M ² / PALETTE	STK / PALETTE PCS / PALLET PCS / PALLETTE	KG / PALETTE KG / PALLET KG / PALLETTE
40 × 120 cm (1198 × 398 × 6 mm)	 M ²	2,0833	10,6250	1,9200	4	20,4000	46,0807	96	489,6000

MARMOR





35 × 100 cm*

Y15005101 021 glänzend · glossy · brillant



35 × 100 cm*

Y15010101 021 matt · mat



5 × 5 cm (30 × 30 cm)

Y15011101 147

matt/glänzend · mat/glossy · mat/brillant

Mosaik · Mosaic · Mosaïque



FORMAT FORMAT FORMAT	PREIS PRO PRICE PER PRIX PAR	STÜCK / M ² PIECES / M ² PIÈCES / M ²	KG / M ² KG / M ² KG / M ²	M ² / KARTON M ² / CARTON M ² / CARTON	STK / KARTON PCS / CARTON PCS / CARTON	KG / KARTON KG / CARTON KG / CARTON	M ² / PALETTE M ² / PALLET M ² / PALLETTE	STK / PALETTE PCS / PALLET PCS / PALLETTE	KG / PALETTE KG / PALLET KG / PALLETTE
35 × 100 cm (998 × 348 × 6 mm)	M ²	2,8571	10,5713	2,1000	6	22,2000	58,8009	168	621,6000
5 × 5 cm (48 × 48 × 6 mm)	STK · PCS	11,1100	9,5546	1,4401	16	13,7600	-	-	-

SEALINE

35 × 100



**UMSTELLUNG
CONVERSION**

35 × 100 cm* 
Y15015101 038 weiß matt · white mat · blanc mat



10 × 100 cm
Y15021001 142 spice honey matt · spice honey mat
Bordüre · Border · Bordure





10 × 100 cm
Y15026001 142 teal matt · teal mat
Bordüre · Border · Bordure



10 × 100 cm
Y15031001 142 atlantic matt · atlantic mat
Bordüre · Border · Bordure

UMSTELLUNG
CONVERSION

FORMAT FORMAT FORMAT	PREIS PRO PRICE PER PRIX PAR	STÜCK / M ² PIECES / M ² PIÈCES / M ²	KG / M ² KG / M ² KG / M ²	M ² / KARTON M ² / CARTON M ² / CARTON	STK / KARTON PCS / CARTON PCS / CARTON	KG / KARTON KG / CARTON KG / CARTON	M ² / PALETTE M ² / PALLET M ² / PALLETTE	STK / PALETTE PCS / PALLET PCS / PALLETTE	KG / PALETTE KG / PALLET KG / PALLETTE
35 × 100 cm (1000 × 350 × 8 mm)	 M ²	2,8571	13,8226	1,4000	4	19,3520	39,2006	112	541,8560
10 × 100 cm (998 × 10 × 6 mm)	 STK · PCS	1,0000**	0,9850**	10,0000**	10	9,8500	-	-	-

** Pro lfm · Per m · Par mètre courant



35 × 100 cm* 
Y15020101 **021** spice honey matt · spice honey mat

UMSTELLUNG
CONVERSION



35 × 100 cm* 
Y15025101 **021** teal matt · teal mat

UMSTELLUNG
CONVERSION

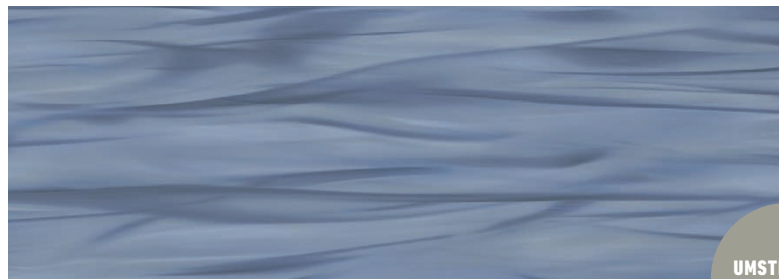

35 × 100 cm* 
Y15030101 **021** atlantic matt · atlantic mat

UMSTELLUNG
CONVERSION

FORMAT FORMAT FORMAT	PREIS PRO PRICE PER PRIX PAR	STÜCK / M ² PIECES / M ² PIÈCES / M ²	KG / M ² KG / M ² KG / M ²	M ² / KARTON M ² / CARTON M ² / CARTON	STK / KARTON PCS / CARTON PCS / CARTON	KG / KARTON KG / CARTON KG / CARTON	M ² / PALETTE M ² / PALLET M ² / PALETTE	STK / PALETTE PCS / PALLET PCS / PALLETTE	KG / PALETTE KG / PALLET KG / PALLETTE
35 × 100 cm (1000 × 350 × 8 mm)	 M ²	2,8571	13,8226	1,4000	4	19,3520	39,2006	112	541,8560

UMSTELLUNG
CONVERSION

SPACE GEM

35 × 100

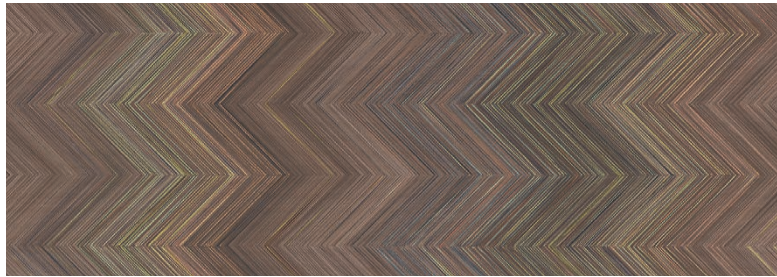

35 × 100 cm*

Y15051001 **125** amber matt · amber mat

Dekor · Decor · Décor

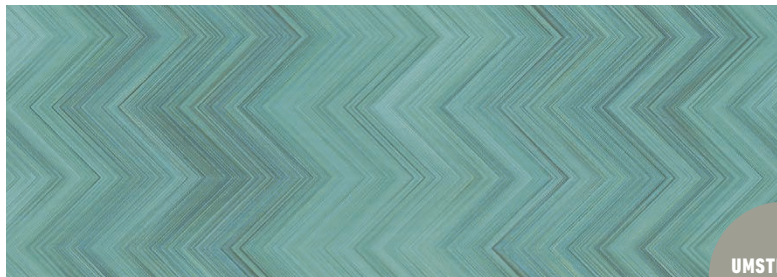

35 × 100 cm*

Y15052101 **125** aura matt · aura mat

Dekor · Decor · Décor



UMSTELLUNG
CONVERSION

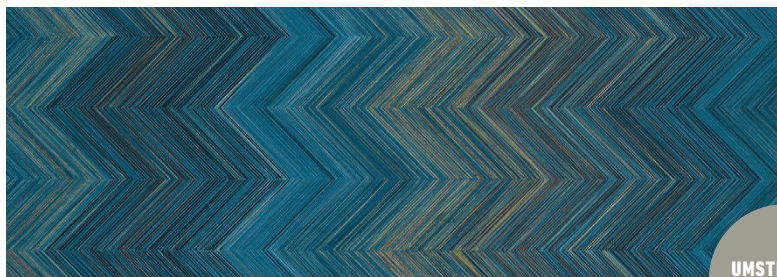



35 × 100 cm*

Y15053101 **125** azur matt · azur mat

Dekor · Decor · Décor



UMSTELLUNG
CONVERSION

FORMAT FORMAT FORMAT	PREIS PRO PRICE PER PRIX PAR	STÜCK / M ² PIECES / M ² PIÈCES / M ²	KG / M ² KG / M ² KG / M ²	M ² / KARTON M ² / CARTON M ² / CARTON	STK / KARTON PCS / CARTON PCS / CARTON	KG / KARTON KG / CARTON KG / CARTON	M ² / PALETTE M ² / PALLET M ² / PALETTE	STK / PALETTE PCS / PALLET PCS / PALLETTE	KG / PALETTE KG / PALLET KG / PALLETTE
35 × 100 cm (1000 × 350 × 8 mm)	 STK · PCS	2,8571	13,8226	1,4000	4	19,3520	-	-	-
35 × 100 cm (998 × 348 × 6 mm)	 STK · PCS	2,8571	10,9998	1,7500	5	19,2500	-	-	-

* Sonderformat - Beachten Sie die Verpackungsinformationen · Special size - notice the packaging information
Format spécial - veuillez noter les informations relatives à l'emballage: Seite · Page 136



UMSTELLUNG
 CONVERSION

35 × 100 cm* 
 Y15054101 125 coral matt · coral mat
 Dekor · Decor · Décor

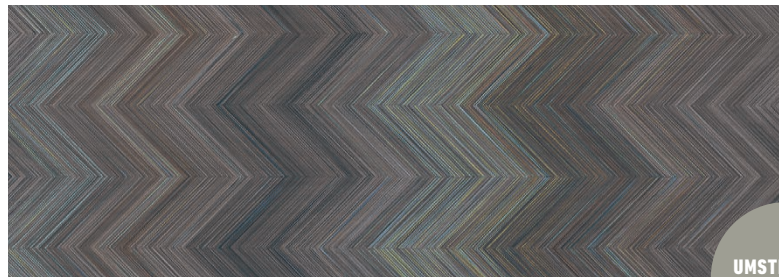

UMSTELLUNG
 CONVERSION

35 × 100 cm* 
 Y15055101 125 onyx matt · onyx mat
 Dekor · Decor · Décor

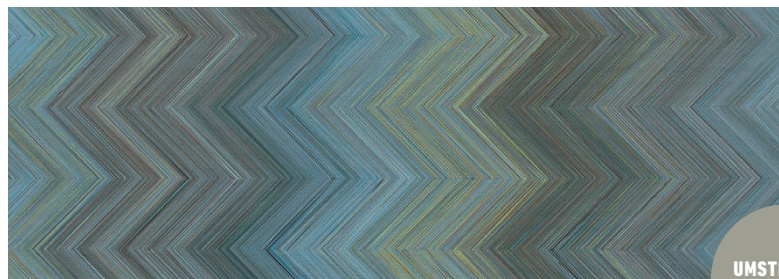

UMSTELLUNG
 CONVERSION

35 × 100 cm* 
 Y15056101 125 rainbow matt · rainbow mat
 Dekor · Decor · Décor



FORMAT FORMAT FORMAT	PREIS PRO PRICE PER PRIX PAR	STÜCK / M ² PIECES / M ² PIÈCES / M ²	KG / M ² KG / M ² KG / M ²	M ² / KARTON M ² / CARTON M ² / CARTON	STK / KARTON PCS / CARTON PCS / CARTON	KG / KARTON KG / CARTON KG / CARTON	M ² / PALETTE M ² / PALLET M ² / PALETTE	STK / PALETTE PCS / PALLET PCS / PALLETTE	KG / PALETTE KG / PALLET KG / PALETTE
35 × 100 cm (1000 × 350 × 8 mm)	 STK · PCS	2,8571	13,8226	1,4000	4	19,3520	-	-	-

UMSTELLUNG
 CONVERSION

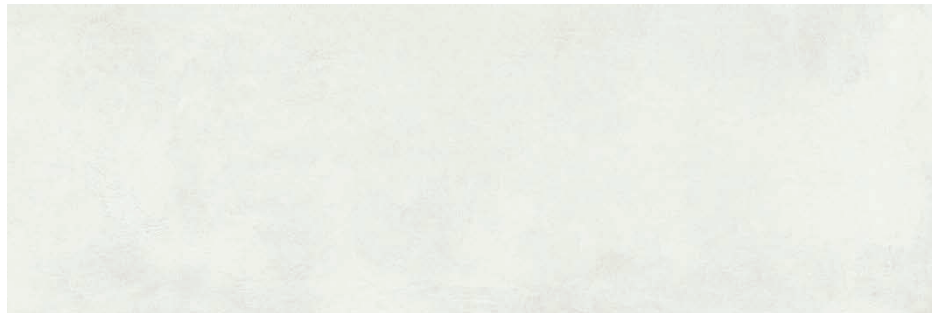

40 × 120 cm*

Y12240101 012 kreide matt · chalk mat · craie mat



40 × 120 cm*

Y12245101 012 sand matt · sand mat · sable mat



40 × 120 cm*

Y12250101 012 granit matt · granite mat

FORMAT FORMAT FORMAT	PREIS PRO PRICE PER PRIX PAR	STÜCK / M ² PIECES / M ² PIÈCES / M ²	KG / M ² KG / M ² KG / M ²	M ² / KARTON M ² / CARTON M ² / CARTON	STK / KARTON PCS / CARTON PCS / CARTON	KG / KARTON KG / CARTON KG / CARTON	M ² / PALETTE M ² / PALLET M ² / PALETTE	STK / PALETTE PCS / PALLET PCS / PALETTE	KG / PALETTE KG / PALLET KG / PALETTE
40 × 120 cm (1198 × 398 × 6 mm)	 M ²	2,0833	10,6250	1,9200	4	20,4000	46,0807	96	489,6000



40 × 120 cm*

Y12241001 132 Fjord kreide matt · chalk mat · craie mat

Dekor · Decor · Décor



40 × 120 cm*

Y12246001 132 Fjord sand matt · sand mat · sable mat

Dekor · Decor · Décor



40 × 120 cm*

Y12251001 132 Fjord granit matt · granite mat

Dekor · Decor · Décor

FORMAT FORMAT FORMAT	PREIS PRO PRICE PER PRIX PAR	STÜCK / M ² PIECES / M ² PIÈCES / M ²	KG / M ² KG / M ² KG / M ²	M ² / KARTON M ² / CARTON M ² / CARTON	STK / KARTON PCS / CARTON PCS / CARTON	KG / KARTON KG / CARTON KG / CARTON	M ² / PALETTE M ² / PALLET M ² / PALETTE	STK / PALETTE PCS / PALLET PCS / PALLETTE	KG / PALETTE KG / PALLET KG / PALETTE
40 × 120 cm (1198 × 398 × 6 mm)	 STK · PCS	2,0833	10,6250	1,9200	4	20,4000	-	-	-

TEARDROP

30 × 60



30 × 60 cm

Y30005001 040 beige matt · beige mat



30 × 60 cm

Y30015001 040 grau matt · grey mat · gris mat

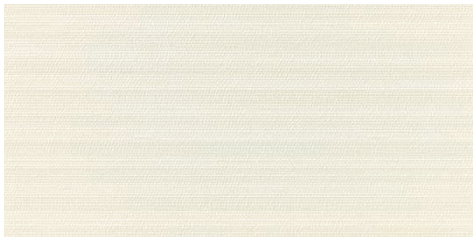

30 × 60 cm

Y30008001 014 Perlen beige matt · beige mat

Flächendekor · Decorated plain tile · Uni décoré



30 × 60 cm

Y30016001 014 Perlen grau matt · grey mat · gris mat

Flächendekor · Decorated plain tile · Uni décoré

FORMAT FORMAT FORMAT	PREIS PRO PRICE PER PRIX PAR	STÜCK / M ² PIECES / M ² PIÈCES / M ²	KG / M ² KG / M ² KG / M ²	M ² / KARTON M ² / CARTON M ² / CARTON	STK / KARTON PCS / CARTON PCS / CARTON	KG / KARTON KG / CARTON KG / CARTON	M ² / PALETTE M ² / PALLET M ² / PALLETTE	STK / PALETTE PCS / PALLET PCS / PALETTE	KG / PALETTE KG / PALLET KG / PALETTE
30 × 60 cm (598 × 298 × 8 mm)	M ²	5,5556	13,1110	1,4400	8	18,8797	86,3930	480	1.132,8000
30 × 60 cm (598 × 298 × 8 mm)	M ²	5,5556	13,1110	1,4400	8	18,8797	86,3930	480	1.132,8000



3,5 × 60 cm

Y30006001 129

opal / rubin / grafit · opal / ruby / graphite · opale / rubis / graphite

Mosaikbordüre · Mosaic border · Mosaïque bordure



4,7 × 60 cm

Y30009001 164

seidenmatt satiniert · semi glossy satinated · satiné

Glasbordüre · Glass border · Bordure verre



2,2 × 60 cm

Y30010001 166 geätzt · etched · corrodé

Edelstahl-Listelli · Stainless steel listel · Listel acier inoxydable



2,2 × 60 cm**

Y30011001 132 geätzt · etched · corrodé

Abschlussbordüre, Oberkante Edelstahl

Border, upper edge stainless steel

Bordure, bord supérieur en acier inoxydable



FORMAT FORMAT FORMAT	PREIS PRO PRICE PER PRIX PAR	STÜCK / M ² PIECES / M ² PIÈCES / M ²	KG / M ² KG / M ² KG / M ²	M ² / KARTON M ² / CARTON M ² / CARTON	STK / KARTON PCS / CARTON PCS / CARTON	KG / KARTON KG / CARTON KG / CARTON	M ² / PALETTE M ² / PALLET M ² / PALETTE	STK / PALETTE PCS / PALLET PCS / PALLETTE	KG / PALETTE KG / PALLET KG / PALLETTE
3,5 × 60 cm (598 × 35 × 8 mm)	STK · PCS	1,6667*	0,5333*	11,9998*	20	6,4000	-	-	-
4,7 × 60 cm (598 × 47 × 8 mm)	STK · PCS	1,6667*	0,8667*	11,9998*	20	10,4000	-	-	-
2,2 × 60 cm (598 × 22 × 8 mm)	STK · PCS	1,6667*	0,2833*	16,7997*	28	4,7600	-	-	-
2,2 × 60 cm (598 × 22 × 8 mm)**	STK · PCS	1,6667*	0,3333*	16,7997*	28	5,6000	-	-	-

* Pro lfm · Per m · Par mètre courant // ** Abschlussbordüre · Upper edge · Bord supérieur

VARIA





30 × 60 cm

Y30520001 019 beige matt · beige mat

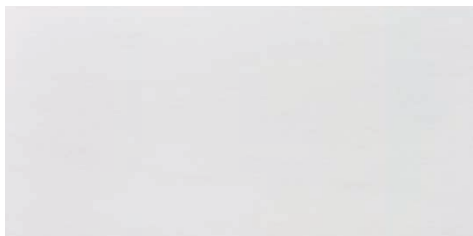

30 × 60 cm

Y30525001 019 weiß matt · white mat · blanc mat



30 × 60 cm

Y30530001 019 grau matt · grey mat · gris mat



25 × 60 cm

Y30521001 141 beige

Mosaik · Mosaic · Mosaïque

geschnitten aus · cut from tile · découpe du carreau: DORATO



25 × 60 cm

Y30526001 141 grau · grey · gris

Mosaik · Mosaic · Mosaïque

geschnitten aus · cut from tile · découpe du carreau: DORATO

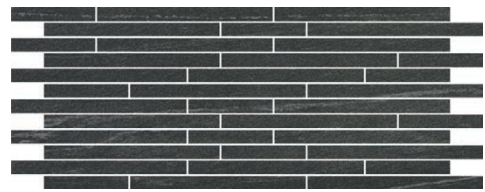

25 × 60 cm

Y30531001 141 anthrazit · anthracite

Mosaik · Mosaic · Mosaïque

geschnitten aus · cut from tile · découpe du carreau: DORATO



FORMAT FORMAT FORMAT	PREIS PRO PRICE PER PRIX PAR	STÜCK / M ² PIECES / M ² PIÈCES / M ²	KG / M ² KG / M ² KG / M ²	M ² / KARTON M ² / CARTON M ² / CARTON	STK / KARTON PCS / CARTON PCS / CARTON	KG / KARTON KG / CARTON KG / CARTON	M ² / PALETTE M ² / PALLET M ² / PALETTE	STK / PALETTE PCS / PALLET PCS / PALLETTE	KG / PALETTE KG / PALLET KG / PALLETTE
30 × 60 cm (598 × 298 × 8 mm)	M ²	5,5556	13,1110	1,4400	8	18,8797	86,3930	480	1.132,8000
25 × 60 cm (598 × 248 × 8 mm)	STK · PCS	6,6667	15,2000	0,9000	6	13,6799	-	-	-



**UMSTELLUNG
CONVERSION**

35 × 100 cm* 
Y15145101 **038** natur · natural · nature





35 × 100 cm*
Y15150001 **038** sand · sable



35 × 100 cm*
Y15151001 **174** Bohle sand · sable
Dekor · Decor · Décor



UMSTELLUNG
CONVERSION

FORMAT FORMAT FORMAT	PREIS PRO PRICE PER PRIX PAR	STÜCK / M ² PIECES / M ² PIÈCES / M ²	KG / M ² KG / M ² KG / M ²	M ² / KARTON M ² / CARTON M ² / CARTON	STK / KARTON PCS / CARTON PCS / CARTON	KG / KARTON KG / CARTON KG / CARTON	M ² / PALETTE M ² / PALLET M ² / PALLETTE	STK / PALETTE PCS / PALLET PCS / PALLETTE	KG / PALETTE KG / PALLET KG / PALLETTE
35 × 100 cm (1000 × 350 × 8 mm)	 M ²	2,8571	13,8226	1,4000	4	19,3520	39,2006	112	541,8560
35 × 100 cm (998 × 348 × 6 mm)	 M ²	2,8571	10,5710	2,1000	6	22,2000	58,8009	168	621,6000
35 × 100 cm (998 × 348 × 6 mm)	 STK · PCS	2,8571	11,0000	1,7500	5	19,2500	-	-	-



UMSTELLUNG
 CONVERSION

35 × 100 cm* 
 Y15155101 038 kalk · limestone · chaux





35 × 100 cm*
 Y15160001 038 stein · stone · pierre



35 × 100 cm*
 Y15161001 174 Bohle stein · stone · pierre
 Dekor · Decor · Décor



FORMAT FORMAT FORMAT	PREIS PRO PRICE PER PRIX PAR	STÜCK / M ² PIECES / M ² PIÈCES / M ²	KG / M ² KG / M ² KG / M ²	M ² / KARTON M ² / CARTON M ² / CARTON	STK / KARTON PCS / CARTON PCS / CARTON	KG / KARTON KG / CARTON KG / CARTON	M ² / PALETTE M ² / PALLET M ² / PALETTE	STK / PALETTE PCS / PALLET PCS / PALETTE	KG / PALETTE KG / PALLET KG / PALETTE
35 × 100 cm (1000 × 350 × 8 mm)	 M ²	2,8571	13,8226	1,4000	4	19,3520	39,2006	112	541,8560
35 × 100 cm (998 × 348 × 6 mm)	 M ²	2,8571	10,5710	2,1000	6	22,2000	58,8009	168	621,6000
35 × 100 cm (998 × 348 × 6 mm)	 STK · PCS	2,8571	11,0000	1,7500	5	19,2500	-	-	-

UMSTELLUNG
 CONVERSION

WONDERWALL

35 × 100



35 × 100 cm*

Y15035001 038 white sun matt · white sun mat





35 × 100 cm*

Y15036001 128 blue moon matt · blue moon mat

Dekor · Decor · Décor



FORMAT FORMAT FORMAT	PREIS PRO PRICE PER PRIX PAR	STÜCK / M ² PIECES / M ² PIÈCES / M ²	KG / M ² KG / M ² KG / M ²	M ² / KARTON M ² / CARTON M ² / CARTON	STK / KARTON PCS / CARTON PCS / CARTON	KG / KARTON KG / CARTON KG / CARTON	M ² / PALETTE M ² / PALLET M ² / PALETTE	STK / PALETTE PCS / PALLET PCS / PALLETTE	KG / PALETTE KG / PALLET KG / PALLETTE
35 × 100 cm (998 × 348 × 6 mm)	 M ²	2,8571	10,5713	2,1000	6	22,2000	58,8009	168	621,6000
35 × 100 cm (998 × 348 × 6 mm)	 STK · PCS	2,8571	10,9998	1,7500	5	19,2500	-	-	-

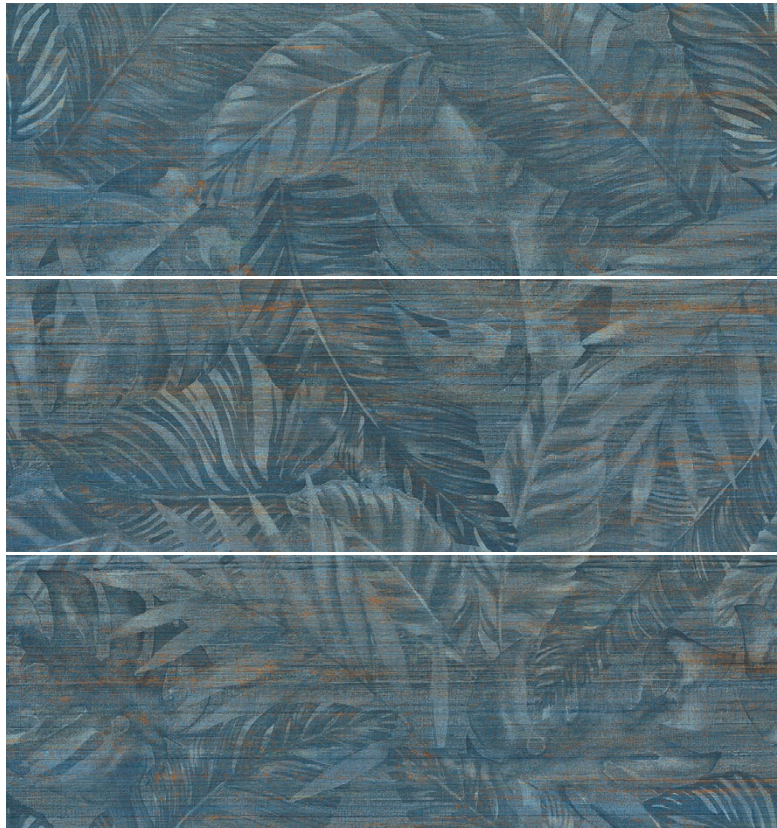

105 × 100 cm*

Y15037001 179 blue jungle matt · blue jungle mat**

Dekorationsset, 1 Stück bestehend aus 3 Teilen à 35 × 100/06 cm

Decor set, 1 pc. consisting of 3 pieces à 35 × 100/06 cm

Décor set, 1 pc. composé de 3 pièces à 35 × 100/06 cm



FORMAT FORMAT FORMAT	PREIS PRO PRICE PER PRIX PAR	STÜCK / M ² PIECES / M ² PIÈCES / M ²	KG / M ² KG / M ² KG / M ²	M ² / KARTON M ² / CARTON M ² / CARTON	STK / KARTON PCS / CARTON PCS / CARTON	KG / KARTON KG / CARTON KG / CARTON	M ² / PALETTE M ² / PALLET M ² / PALETTE	STK / PALETTE PCS / PALLET PCS / PALETTE	KG / PALETTE KG / PALLET KG / PALLETTE
105 × 100 cm (998 × 1048 × 6 mm)	 STK · PCS	2,8571	11,000	0,9524	1	11,5500	-	-	-

** Anzahl der Dekormotive · Number of decor motifs · Nombre de motifs: 3

PUREWALL

PURE WHITE

30 × 60

Steingut · Wall tile · Faïence

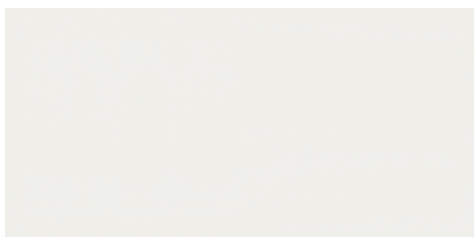

30 × 60 cm

Y30090101 * weiß glänzend · white glossy · blanc brillant

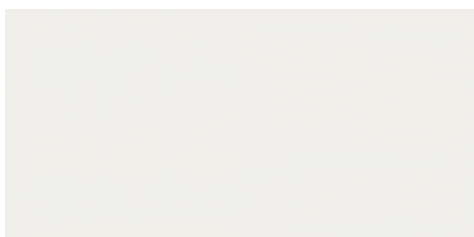

30 × 60 cm

Y30095101 * weiß matt · white mat · blanc mat



30 × 60 cm

Y30091101 157 Belle weiß glänzend · white glossy · blanc brillant

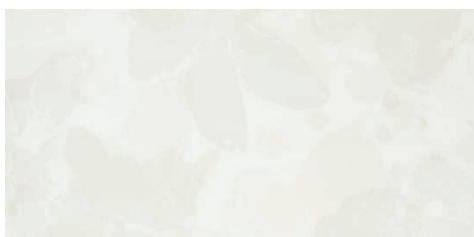

Dekor · Decor · Décor



30 × 60 cm

Y30096101 157 Belle weiß matt · white mat · blanc mat

Dekor · Decor · Décor

FORMAT FORMAT FORMAT	PREIS PRO PRICE PER PRIX PAR	STÜCK / M ² PIECES / M ² PIÈCES / M ²	KG / M ² KG / M ² KG / M ²	M ² / KARTON M ² / CARTON M ² / CARTON	STK / KARTON PCS / CARTON PCS / CARTON	KG / KARTON KG / CARTON KG / CARTON	M ² / PALETTE M ² / PALLET M ² / PALETTE	STK / PALETTE PCS / PALLET PCS / PALLET	KG / PALETTE KG / PALLET KG / PALLET
30 × 60 cm (598 × 298 × 8 mm)	 M ²	5,5556	13,1110	1,4400	8	18,8797	86,3930	480	1.132,8000
30 × 60 cm (598 × 298 × 8 mm)	 STK · PCS	5,5556	13,1110	1,0800	6	14,1598	-	-	-

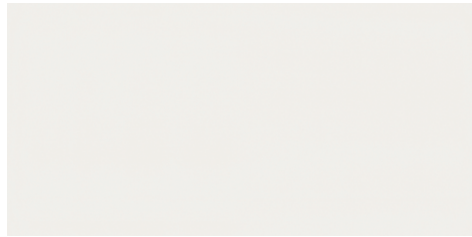

30 × 60 cm

Y30600101 * weiß glänzend · white glossy · blanc brillant

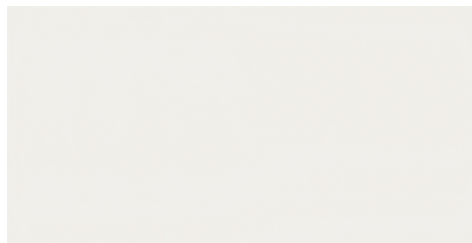

30 × 60 cm

Y30605101 * weiß matt · white mat · blanc mat



30 × 60 cm

Y30601101 104 Belle weiß glänzend · white glossy · blanc brillant

Dekor · Decor · Décor



30 × 60 cm

Y30606101 104 Belle weiß matt · white mat · blanc mat

Dekor · Decor · Décor

FORMAT FORMAT FORMAT	PREIS PRO PRICE PER PRIX PAR	STÜCK / M ² PIECES / M ² PIÈCES / M ²	KG / M ² KG / M ² KG / M ²	M ² / KARTON M ² / CARTON M ² / CARTON	STK / KARTON PCS / CARTON PCS / CARTON	KG / KARTON KG / CARTON KG / CARTON	M ² / PALETTE M ² / PALLET M ² / PALETTE	STK / PALETTE PCS / PALLET PCS / PALLETTE	KG / PALETTE KG / PALLET KG / PALLETTE
30 × 60 cm (598 × 298 × 8 mm)	M ²	5,5556	13,1110	1,4400	8	18,8797	86,3930	480	1.132,8000
30 × 60 cm (598 × 298 × 8 mm)	STK · PCS	5,5556	13,1110	1,0800	6	14,1598	-	-	-

* Siehe separates Preisblatt

Please see the separate price list · Voir la liste des prix séparée

PURE WHITE

30 × 60

Steingut · Wall tile · Faïence

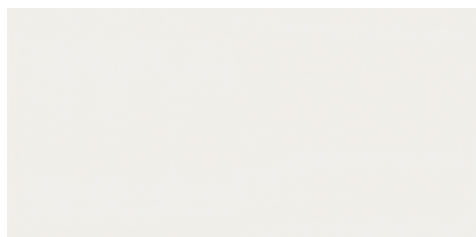

30 × 60 cm

Y31201001 * weiß glänzend · white glossy · blanc brillant

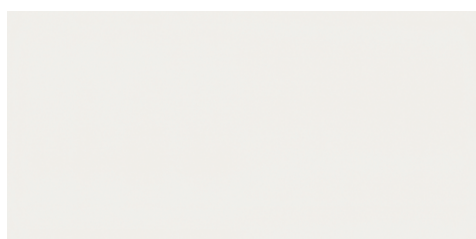

30 × 60 cm

Y31290001 * weiß matt · white mat · blanc mat

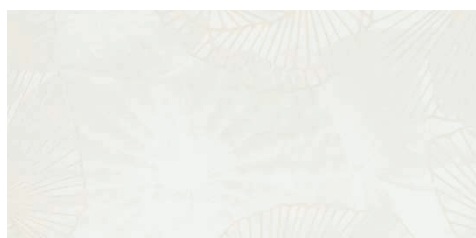

30 × 60 cm

Y31202001 006 Lotus weiß glänzend · white glossy · blanc brillant

Flächendekor · Decorated plain tile · Uni décoré



30 × 60 cm

Y31291001 006 Lotus weiß matt · white mat · blanc mat

Flächendekor · Decorated plain tile · Uni décoré

FORMAT FORMAT FORMAT	PREIS PRO PRICE PER PRIX PAR	STÜCK / M ² PIECES / M ² PIÈCES / M ²	KG / M ² KG / M ² KG / M ²	M ² / KARTON M ² / CARTON M ² / CARTON	STK / KARTON PCS / CARTON PCS / CARTON	KG / KARTON KG / CARTON KG / CARTON	M ² / PALETTE M ² / PALLET M ² / PALLETTE	STK / PALETTE PCS / PALLET PCS / PALLETTE	KG / PALETTE KG / PALLET KG / PALLETTE
30 × 60 cm (598 × 298 × 6 mm)	M ²	5,5556	10,0560	1,4400	8	14,4805	103,6720	576	1.042,5600
30 × 60 cm (598 × 298 × 6 mm)	M ²	5,5556	10,0560	1,4400	8	14,4805	103,6720	576	1.042,5600

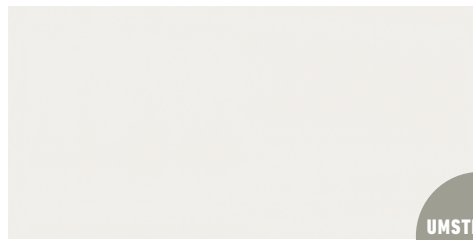

UMSTELLUNG
CONVERSION

30 × 60 cm



Y32201101 * weiß glänzend · white glossy · blanc brillant

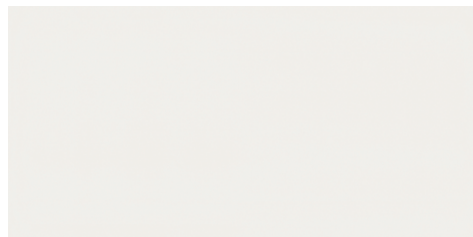

30 × 60 cm

Y32290001 * weiß matt · white mat · blanc mat



30 × 60 cm

Y32202001 040 Leaves weiß glänzend · white glossy · blanc brillant

Flächendekor · Decorated plain tile · Uni décoré

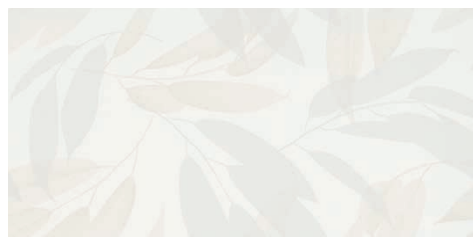

30 × 60 cm

Y32291001 040 Leaves weiß matt · white mat · blanc mat

Flächendekor · Decorated plain tile · Uni décoré

FORMAT FORMAT FORMAT	PREIS PRO PRICE PER PRIX PAR	STÜCK / M ² PIECES / M ² PIÈCES / M ²	KG / M ² KG / M ² KG / M ²	M ² / KARTON M ² / CARTON M ² / CARTON	STK / KARTON PCS / CARTON PCS / CARTON	KG / KARTON KG / CARTON KG / CARTON	M ² / PALETTE M ² / PALLET M ² / PALLETTE	STK / PALETTE PCS / PALLET PCS / PALLETTE	KG / PALETTE KG / PALLET KG / PALLETTE
30 × 60 cm (598 × 298 × 6 mm)	M ²	5,5556	11,4000	1,8000	10	19,0000	107,9991	600	1.140,0000
30 × 60 cm (598 × 298 × 6 mm)	M ²	5,5556	10,0560	1,4400	8	14,4805	103,6720	576	1.042,5600
30 × 60 cm (598 × 298 × 6 mm)	M ²	5,5556	10,0560	1,4400	8	14,4805	103,6720	576	1.042,5600

* Siehe separates Preisblatt

Please see the separate price list · Voir la liste des prix séparée

PURE WHITE

35 × 100

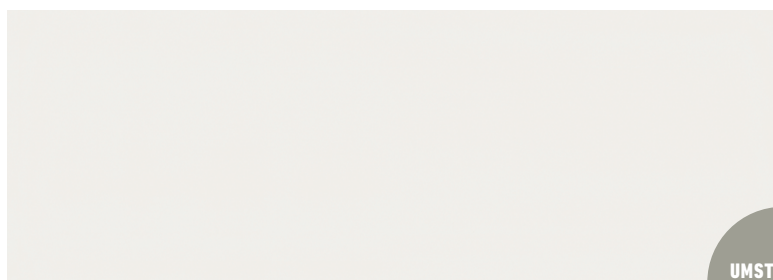

**UMSTELLUNG
CONVERSION**

35 × 100 cm* 
Y15500101 * weiß glänzend · white glossy · blanc brillant

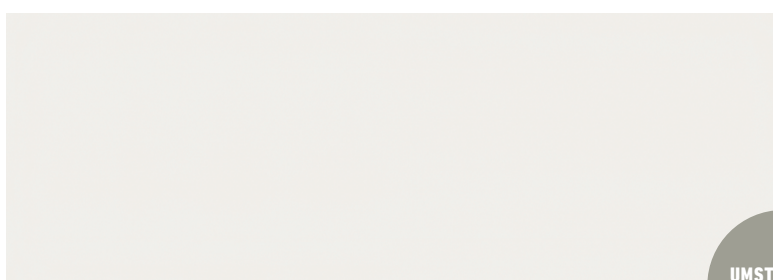

**UMSTELLUNG
CONVERSION**

35 × 100 cm* 
Y15505101 * weiß matt · white mat · blanc mat

UMSTELLUNG
CONVERSION

FORMAT FORMAT FORMAT	PREIS PRO PRICE PER PRIX PAR	STÜCK / M ² PIECES / M ² PIÈCES / M ²	KG / M ² KG / M ² KG / M ²	M ² / KARTON M ² / CARTON M ² / CARTON	STK / KARTON PCS / CARTON PCS / CARTON	KG / KARTON KG / CARTON KG / CARTON	M ² / PALETTE M ² / PALLET M ² / PALLETTE	STK / PALETTE PCS / PALLET PCS / PALLETTE	KG / PALETTE KG / PALLET KG / PALLETTE
35 × 100 cm (1000 × 350 × 8 mm)	 M ²	2,8571	13,8226	1,4000	4	19,3520	39,2006	112	541,8560



35 × 100 cm*

Y15501001 **164** Shadow weiß glänzend · white glossy · blanc brillant

Dekor · Decor · Décor



35 × 100 cm*

Y15506001 **164** Shadow weiß matt · white mat · blanc mat

Dekor · Decor · Décor

FORMAT FORMAT FORMAT	PREIS PRO PRICE PER PRIX PAR	STÜCK / M ² PIECES / M ² PIÈCES / M ²	KG / M ² KG / M ² KG / M ²	M ² / KARTON M ² / CARTON M ² / CARTON	STK / KARTON PCS / CARTON PCS / CARTON	KG / KARTON KG / CARTON KG / CARTON	M ² / PALETTE M ² / PALLET M ² / PALETTE	STK / PALETTE PCS / PALLET PCS / PALLETTE	KG / PALETTE KG / PALLET KG / PALLETTE
35 × 100 cm (998 × 348 × 6 mm)	 STK · PCS	2,8571	10,9998	1,7500	5	19,2500	-	-	-

* Siehe separates Preisblatt

Please see the separate price list · Voir la liste des prix séparée

PURE WHITE

35 × 100



**UMSTELLUNG
CONVERSION**

35 × 100 cm* 

Y15510101 * Wave weiß glänzend · white glossy · blanc brillant
gewellt · undulated surface · surface ondulée



**UMSTELLUNG
CONVERSION**

35 × 100 cm* 

Y15515101 * Wave weiß matt · white mat · blanc mat
gewellt · undulated surface · surface ondulée

UMSTELLUNG
CONVERSION

FORMAT FORMAT FORMAT	PREIS PRO PRICE PER PRIX PAR	STÜCK / M ² PIECES / M ² PIÈCES / M ²	KG / M ² KG / M ² KG / M ²	M ² / KARTON M ² / CARTON M ² / CARTON	STK / KARTON PCS / CARTON PCS / CARTON	KG / KARTON KG / CARTON KG / CARTON	M ² / PALETTE M ² / PALLET M ² / PALLETTE	STK / PALETTE PCS / PALLET PCS / PALLETTE	KG / PALETTE KG / PALLET KG / PALLETTE
35 × 100 cm (1000 × 350 × 8 mm)	 M ²	2,8571	13,8226	1,4000	4	19,3520	39,2006	112	541,8560



35 × 100 cm*

Y15511001 **164** Laila weiß glänzend · white glossy · blanc brillant

gewellt · undulated surface · surface ondulée

Dekor · Decor · Décor



35 × 100 cm*

Y15516001 **164** Laila weiß matt · white mat · blanc mat

gewellt · undulated surface · surface ondulée

Dekor · Decor · Décor

FORMAT FORMAT FORMAT	PREIS PRO PRICE PER PRIX PAR	STÜCK / M ² PIECES / M ² PIÈCES / M ²	KG / M ² KG / M ² KG / M ²	M ² / KARTON M ² / CARTON M ² / CARTON	STK / KARTON PCS / CARTON PCS / CARTON	KG / KARTON KG / CARTON KG / CARTON	M ² / PALETTE M ² / PALLET M ² / PALETTE	STK / PALETTE PCS / PALLET PCS / PALLETTE	KG / PALETTE KG / PALLET KG / PALLETTE
35 × 100 cm (998 × 348 × 6 mm)	 STK · PCS	2,8571	10,9998	1,7500	5	19,2500	-	-	-

* Siehe separates Preisblatt

Please see the separate price list · Voir la liste des prix séparée

PURE WHITE

40 × 120



40 × 120 cm*

Y12300001 * weiß glänzend · white glossy · blanc brillant

gewellt · undulated surface · surface ondulée



40 × 120 cm*

Y12305001 * weiß matt · white mat · blanc mat

gewellt · undulated surface · surface ondulée

FORMAT FORMAT FORMAT	PREIS PRO PRICE PER PRIX PAR	STÜCK / M ² PIECES / M ² PIÈCES / M ²	KG / M ² KG / M ² KG / M ²	M ² / KARTON M ² / CARTON M ² / CARTON	STK / KARTON PCS / CARTON PCS / CARTON	KG / KARTON KG / CARTON KG / CARTON	M ² / PALETTE M ² / PALLET M ² / PALETTE	STK / PALETTE PCS / PALLET PCS / PALLETTE	KG / PALETTE KG / PALLET KG / PALLETTE
40 × 120 cm (1198 × 398 × 6mm)	 M ²	2,0833	10,6250	1,9200	4	20,4000	46,0807	96	489,6000



40 × 120 cm*

Y12310001 164 Mainau weiß glänzend · white glossy · blanc brillant

gewellt · undulated surface · surface ondulée

Dekor · Decor · Décor



40 × 120 cm*

Y12315001 164 Samoa weiß matt · white mat · blanc mat

gewellt · undulated surface · surface ondulée

Dekor · Decor · Décor



FORMAT FORMAT FORMAT	PREIS PRO PRICE PER PRIX PAR	STÜCK / M ² PIECES / M ² PIÈCES / M ²	KG / M ² KG / M ² KG / M ²	M ² / KARTON M ² / CARTON M ² / CARTON	STK / KARTON PCS / CARTON PCS / CARTON	KG / KARTON KG / CARTON KG / CARTON	M ² / PALETTE M ² / PALLET M ² / PALETTE	STK / PALETTE PCS / PALLET PCS / PALLETTE	KG / PALETTE KG / PALLET KG / PALLETTE
40 × 120 cm (1198 × 398 × 6mm)	 STK · PCS	2,0833	10,6250	1,9200	4	20,4000	-	-	-

* Siehe separates Preisblatt

Please see the separate price list · Voir la liste des prix séparée

PURE WHITE



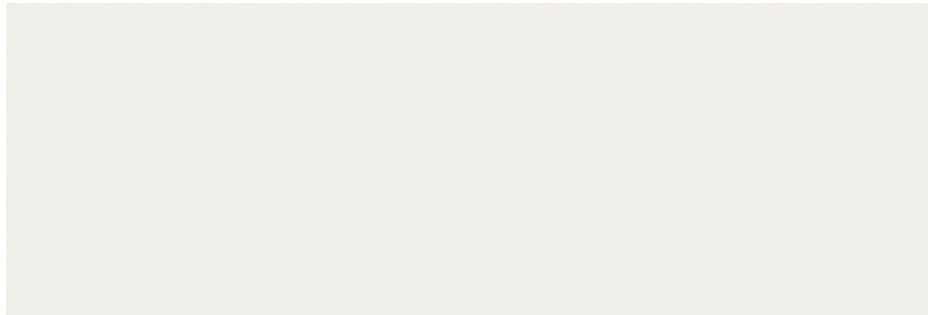

40 × 120 cm*

Y12975101 * weiß glänzend · white glossy · blanc brillant

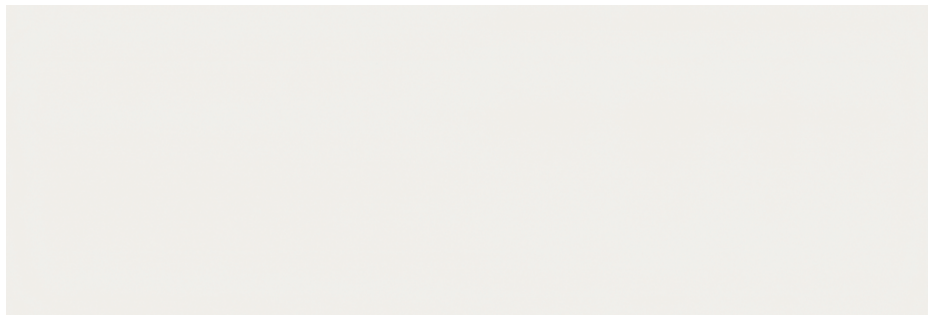

40 × 120 cm*

Y12980101 * weiß matt · white mat · blanc mat

FORMAT FORMAT FORMAT	PREIS PRO PRICE PER PRIX PAR	STÜCK / M ² PIECES / M ² PIÈCES / M ²	KG / M ² KG / M ² KG / M ²	M ² / KARTON M ² / CARTON M ² / CARTON	STK / KARTON PCS / CARTON PCS / CARTON	KG / KARTON KG / CARTON KG / CARTON	M ² / PALETTE M ² / PALLET M ² / PALETTE	STK / PALETTE PCS / PALLET PCS / PALLETTE	KG / PALETTE KG / PALLET KG / PALETTE
40 × 120 cm (1198 × 398 × 6mm)	 M ²	2,0833	10,3640	1,9200	4	19,9000	46,0807	96	477,6000

* Siehe separates Preisblatt

Please see the separate price list · Voir la liste des prix séparée

VANILLE

30 × 60

Steingut · Wall tile · Faïence



30 × 60 cm

Y30100101 * vanille glänzend · vanilla glossy · vanille brillant

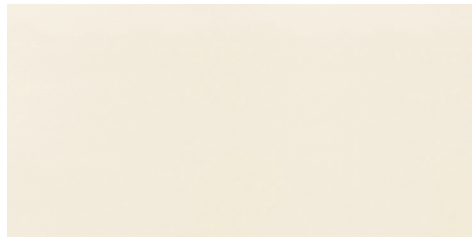

30 × 60 cm

Y30105101 * vanille matt · vanilla mat · vanille mat

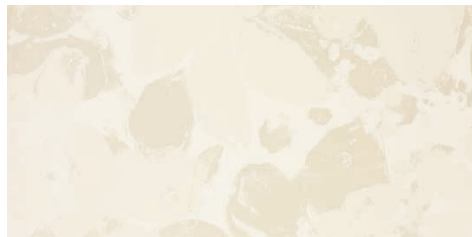

30 × 60 cm

Y30101101 157 Belle vanille glänzend · vanilla glossy · vanille brillant

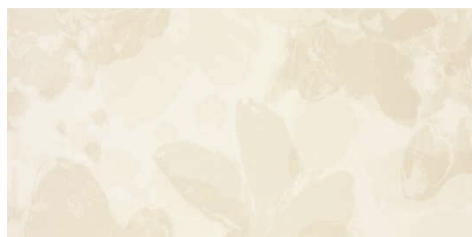

Dekor · Decor · Décor



30 × 60 cm

Y30106101 157 Belle vanille matt · vanilla mat · vanille mat

Dekor · Decor · Décor

FORMAT FORMAT FORMAT	PREIS PRO PRICE PER PRIX PAR	STÜCK / M ² PIECES / M ² PIÈCES / M ²	KG / M ² KG / M ² KG / M ²	M ² / KARTON M ² / CARTON M ² / CARTON	STK / KARTON PCS / CARTON PCS / CARTON	KG / KARTON KG / CARTON KG / CARTON	M ² / PALETTE M ² / PALLET M ² / PALLETTE	STK / PALETTE PCS / PALLET PCS / PALLETTE	KG / PALETTE KG / PALLET KG / PALLETTE
30 × 60 cm (598 × 298 × 8 mm)	 M ²	5,5556	13,1110	1,4400	8	18,8797	86,3930	480	1.132,8000
30 × 60 cm (598 × 298 × 8 mm)	 STK · PCS	5,5556	13,1110	1,0800	6	14,1598	-	-	-



30 × 60 cm

Y30620101 * vanille glänzend · vanilla glossy · vanille brillant

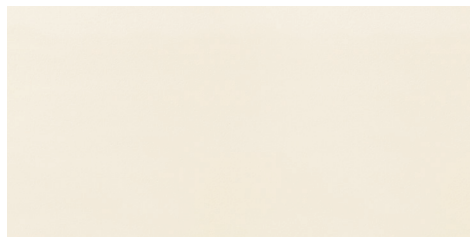

30 × 60 cm

Y30625101 * vanille matt · vanilla mat · vanille mat

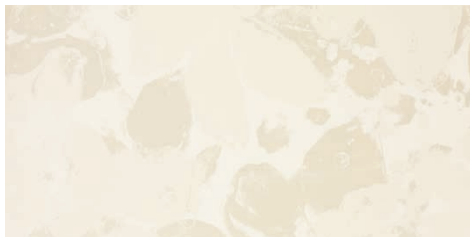

30 × 60 cm

Y30621101 104 Belle vanille glänzend · vanilla glossy · vanille brillant

Dekor · Decor · Décor

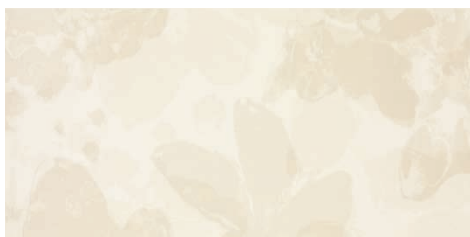

30 × 60 cm

Y30626101 104 Belle vanille matt · vanilla mat · vanille mat

Dekor · Decor · Décor

FORMAT FORMAT FORMAT	PREIS PRO PRICE PER PRIX PAR	STÜCK / M ² PIECES / M ² PIÈCES / M ²	KG / M ² KG / M ² KG / M ²	M ² / KARTON M ² / CARTON M ² / CARTON	STK / KARTON PCS / CARTON PCS / CARTON	KG / KARTON KG / CARTON KG / CARTON	M ² / PALETTE M ² / PALLET M ² / PALETTE	STK / PALETTE PCS / PALLET PCS / PALLETTE	KG / PALETTE KG / PALLET KG / PALLETTE
30 × 60 cm (598 × 298 × 8 mm)	M ²	5,5556	13,1110	1,4400	8	18,8797	86,3930	480	1.132,8000
30 × 60 cm (598 × 298 × 8 mm)	STK · PCS	5,5556	13,1110	1,0800	6	14,1598	-	-	-

* Siehe separates Preisblatt

Please see the separate price list · Voir la liste des prix séparée

FEINSTEINZEUG
PORCELAIN GRES
GRÈS CÉRAMÉ

BELFORT





60 × 90 60 × 60 30 × 60



60 × 90 cm
 Y62700001 092 sand · sable



60 × 60 cm
 Y62340001 056 sand · sable



5 × 5 cm (30 × 30 cm)
 Mosaik · Mosaic · Mosaique
 147
 Y68037001 sand · sable

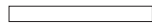

7 × 60 cm
 Sockel · Plinth · Plinthe
 159
 Y68036101 sand · sable



30 × 60 cm
 Y68035001 078 sand · sable

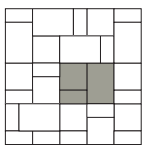

BEISPIELE FÜR FLÄCHENVERLEGUNGEN UND BERECHNUNGEN: SEITE 138
 EXAMPLES FOR LAYINGS AND CALCULATIONS: PAGE 138
 EXEMPLES POUR SURFACES POSE ET CALCUL: PAGE 138

FORMAT FORMAT FORMAT	PREIS PRO PRICE PER PRIX PAR	STÜCK / M ² PIECES / M ² PIÈCES / M ²	KG / M ² KG / M ² KG / M ²	M ² / KARTON M ² / CARTON M ² / CARTON	STK / KARTON PCS / CARTON PCS / CARTON	KG / KARTON KG / CARTON KG / CARTON	M ² / PALETTE M ² / PALLET M ² / PALETTE	STK / PALETTE PCS / PALLET PCS / PALETTE	KG / PALETTE KG / PALLET KG / PALLETTE
60 × 90 cm (906 × 604 × 10 mm)	M ²	1,8519	22,2970	1,0800	2	24,0801	51,8360	96	1.155,8400
60 × 60 cm (604 × 604 × 10 mm)	M ²	2,7778	22,2950	1,0800	3	24,0784	43,1970	120	963,1200
30 × 60 cm (604 × 302 × 10 mm)	M ²	5,5556	22,2950	1,0800	6	24,0784	43,1970	240	963,1200
5 × 5 cm (48 × 48 × 10 mm)	STK · PCS	11,1110	22,3330	0,9900	11	22,1099	-	-	-
7 × 60 cm (604 × 70 × 10 mm)	STK · PCS	1,6667*	1,6667*	5,9999*	10	10,0000	-	-	-

* Pro lfm · Per m · Par mètre courant

BELFORT

60 × 90 60 × 60 30 × 60



60 × 90 cm
Y62705001 092 clay



60 × 60 cm
Y62345001 056 clay



5 × 5 cm (30 × 30 cm)
Mosaik · Mosaic · Mosaïque
147

Y68042001 clay

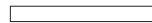

7 × 60 cm
Sockel · Plinth · Plinthe
159

Y68041101 clay



30 × 60 cm
Y68040001 078 clay

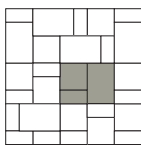

BEISPIELE FÜR FLÄCHENVERLEGUNGEN UND BERECHNUNGEN: SEITE 138
EXAMPLES FOR LAYINGS AND CALCULATIONS: PAGE 138
EXEMPLES POUR SURFACES POSE ET CALCUL: PAGE 138

FORMAT FORMAT FORMAT	PREIS PRO PRICE PER PRIX PAR	STÜCK / M ² PIECES / M ² PIÈCES / M ²	KG / M ² KG / M ² KG / M ²	M ² / KARTON M ² / CARTON M ² / CARTON	STK / KARTON PCS / CARTON PCS / CARTON	KG / KARTON KG / CARTON KG / CARTON	M ² / PALETTE M ² / PALLET M ² / PALETTE	STK / PALETTE PCS / PALLET PCS / PALETTE	KG / PALETTE KG / PALLET KG / PALLET
60 × 90 cm (906 × 604 × 10 mm)	M ²	1,8519	22,2970	1,0800	2	24,0801	51,8360	96	1.155,8400
60 × 60 cm (604 × 604 × 10 mm)	M ²	2,7778	22,2950	1,0800	3	24,0784	43,1970	120	963,1200
30 × 60 cm (604 × 302 × 10 mm)	M ²	5,5556	22,2950	1,0800	6	24,0784	43,1970	240	963,1200
5 × 5 cm (48 × 48 × 10 mm)	STK · PCS	11,1110	22,3330	0,9900	11	22,1099	-	-	-
7 × 60 cm (604 × 70 × 10 mm)	STK · PCS	1,6667*	1,6667*	5,9999*	10	10,0000	-	-	-

* Pro lfm · Per m · Par mètre courant

60 × 90

60 × 60

30 × 60



60 × 90 cm
Y62710001 092 basalt



60 × 60 cm
Y62350001 056 basalt



5 × 5 cm (30 × 30 cm)
Mosaik · Mosaic · Mosaïque
147

Y68047001 basalt

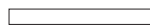

7 × 60 cm
Sockel · Plinth · Plinthe
159

Y68046101 basalt



30 × 60 cm
Y68045001 078 basalt

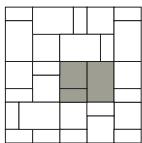

BEISPIELE FÜR FLÄCHENVERLEGUNGEN UND BERECHNUNGEN: SEITE 138
EXAMPLES FOR LAYINGS AND CALCULATIONS: PAGE 138
EXEMPLES POUR SURFACES POSE ET CALCUL: PAGE 138

FORMAT FORMAT FORMAT	PREIS PRO PRICE PER PRIX PAR	STÜCK / M ² PIECES / M ² PIÈCES / M ²	KG / M ² KG / M ² KG / M ²	M ² / KARTON M ² / CARTON M ² / CARTON	STK / KARTON PCS / CARTON PCS / CARTON	KG / KARTON KG / CARTON KG / CARTON	M ² / PALETTE M ² / PALLET M ² / PALETTE	STK / PALETTE PCS / PALLET PCS / PALLETTE	KG / PALETTE KG / PALLET KG / PALLETTE
60 × 90 cm (906 × 604 × 10 mm)	M ²	1,8519	22,2970	1,0800	2	24,0801	51,8360	96	1.155,8400
60 × 60 cm (604 × 604 × 10 mm)	M ²	2,7778	22,2950	1,0800	3	24,0784	43,1970	120	963,1200
30 × 60 cm (604 × 302 × 10 mm)	M ²	5,5556	22,2950	1,0800	6	24,0784	43,1970	240	963,1200
5 × 5 cm (48 × 48 × 10 mm)	STK · PCS	11,1110	22,3330	0,9900	11	22,1099	-	-	-
7 × 60 cm (604 × 70 × 10 mm)	STK · PCS	1,6667*	1,6667*	5,9999*	10	10,0000	-	-	-

* Pro lfm · Per m · Par mètre courant

CHALET

20 × 120



20 × 120 cm

Y66560101 060 cream



20 × 120 cm 

Y66570201 060 cherry

UMSTELLUNG
CONVERSION



20 × 120 cm

Y66575101 060 cognac



5 × 5 cm (30 × 30 cm)

Mosaik · Mosaic · Mosaïque

147

Y66561101 cream

Y66571101 cherry

Y66576101 cognac



7 × 120 cm

Sockel · Plinth · Plinthe

145





Y66563101 cream

Y66573101 cherry

Y66578101 cognac



UMSTELLUNG
CONVERSION

FORMAT FORMAT FORMAT	PREIS PRO PRICE PER PRIX PAR	STÜCK / M ² PIECES / M ² PIÈCES / M ²	KG / M ² KG / M ² KG / M ²	M ² / KARTON M ² / CARTON M ² / CARTON	STK / KARTON PCS / CARTON PCS / CARTON	KG / KARTON KG / CARTON KG / CARTON	M ² / PALETTE M ² / PALLET M ² / PALETTE	STK / PALETTE PCS / PALLET PCS / PALLETTE	KG / PALETTE KG / PALLET KG / PALETTE
20 × 120 cm (1198 × 198 × 6 mm)	 M ²	4,1667	14,0251	1,6800	7	23,5620	53,7596	224	753,9840
20 × 120 cm (1198 × 198 × 6 mm)	 M ²	4,1667	14,0251	1,6800	7	23,5620	50,3996	210	706,8600
5 × 5 cm (48 × 48 × 6 mm)	 STK · PCS	11,1110	13,9999	1,4400	16	20,1600	-	-	-
7 × 120 cm (1198 × 70 × 6 mm)	 STK · PCS	0,8333*	0,9282*	12,0005*	10	11,1387	-	-	-

* Pro lfm · Per m · Par mètre courant

Bitte beachten Sie die geänderte Materialstärke ·

Please note the changed material thickness · Veuillez noter l'épaisseur de matériau dodifiée



39 × 47 cm

Y66562101 183 multicream

Mosaik · Mosaic · Mosaïque



39 × 47 cm

Y66572101 183 multicherry

Mosaik · Mosaic · Mosaïque



39 × 47 cm

Y66577101 183 multicognac

Mosaik · Mosaic · Mosaïque



FORMAT FORMAT FORMAT	PREIS PRO PRICE PER PRIX PAR	STÜCK / M ² PIECES / M ² PIÈCES / M ²	KG / M ² KG / M ² KG / M ²	M ² / KARTON M ² / CARTON M ² / CARTON	STK / KARTON PCS / CARTON PCS / CARTON	KG / KARTON KG / CARTON KG / CARTON	M ² / PALETTE M ² / PALLET M ² / PALETTE	STK / PALETTE PCS / PALLET PCS / PALLETTE	KG / PALETTE KG / PALLET KG / PALLETTE
39 × 47 cm (470 × 390 × 6 mm)	 STK · PCS	5,4560	14,0219	1,6496	9	23,1300	-	-	-

Bitte beachten Sie die geänderte Materialstärke ·

Please note the changed material thickness · Veuillez noter l'épaisseur de matériau modifiée



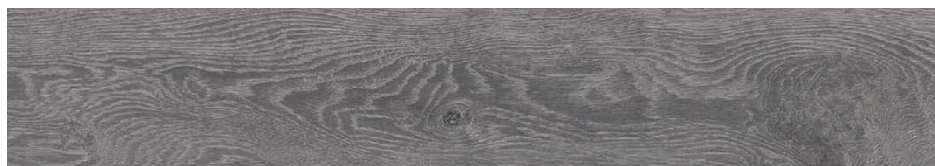

20 × 120 cm

Y74025101 * rauch · smoky · fumée



20 × 120 cm

Y74030101 * barrique

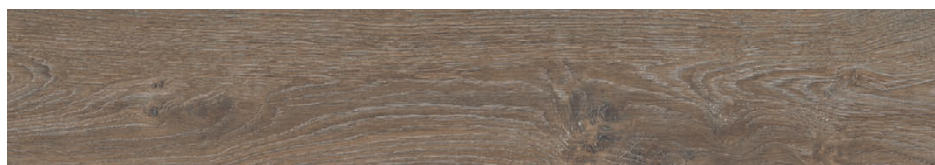

20 × 120 cm

Y74035101 * cognac



5 × 5 cm (30 × 30 cm)

Mosaik · Mosaic · Mosaïque

*

Y74027101 rauch · smoky · fumée

Y74032101 barrique

Y74037101 cognac



7 × 120 cm

Sockel · Plinth · Plinthe

*

Y74026101 rauch · smoky · fumée

Y74031101 barrique

Y74036101 cognac



FORMAT FORMAT FORMAT	PREIS PRO PRICE PER PRIX PAR	STÜCK / M ² PIECES / M ² PIÈCES / M ²	KG / M ² KG / M ² KG / M ²	M ² / KARTON M ² / CARTON M ² / CARTON	STK / KARTON PCS / CARTON PCS / CARTON	KG / KARTON KG / CARTON KG / CARTON	M ² / PALETTE M ² / PALLET M ² / PALLETTE	STK / PALETTE PCS / PALLET PCS / PALLETTE	KG / PALETTE KG / PALLET KG / PALLETTE
20 × 120 cm (1198 × 198 × 6 mm)	M ²	4,1667	14,0251	1,6800	7	23,5620	50,3996	210	706,8600
5 × 5 cm (48 × 48 × 6 mm)	STK · PCS	11,1110	13,9999	1,4400	16	20,1600	-	-	-
7 × 120 cm (1198 × 70 × 6 mm)	STK · PCS	0,8333*	0,9489*	12,0005*	10	11,3870	-	-	-

* Pro lfm · Per m · Par mètre courant

* Siehe separates Preisblatt

Please see the separate price list · Voir la liste des prix séparée

GOLD TILES





7,2 × 7,2 cm (30 × 30 cm)

Y65015001 099 realgold

netzverklebt · glued on mesh-type net · collé sur maillage

Mosaik · Mosaic · Mosaïque

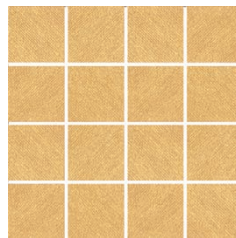

7,2 × 7,2 cm (30 × 30 cm)

Y65025001 099 Royal realgold

netzverklebt · glued on mesh-type net · collé sur maillage

Mosaik · Mosaic · Mosaïque



FORMAT FORMAT FORMAT	PREIS PRO PRICE PER PRIX PAR	STÜCK / M ² PIECES / M ² PIÈCES / M ²	KG / M ² KG / M ² KG / M ²	M ² / KARTON M ² / CARTON M ² / CARTON	STK / KARTON PCS / CARTON PCS / CARTON	KG / KARTON KG / CARTON KG / CARTON	M ² / PALETTE M ² / PALLET M ² / PALETTE	STK / PALETTE PCS / PALLET PCS / PALETTE	KG / PALETTE KG / PALLET KG / PALETTE
7,2 × 7,2 cm (72 × 72 × 8 mm)	M ²	11,0000	18,7000	1,0000	11	18,7000	48,0000	528	897,6000



Auftragsfertigung - Lieferzeit beachten

Commissioned production - notice delivery time

Production sur commande - veuillez noter le délai de livraison

HOLMEN

120 × 278 100 × 100 60 × 60
120 × 120 60 × 120



NEU
NEW
NEUF



100 × 100 cm
Y12620001 066 sand · sable



60 × 60 cm
Y69200001 057 sand · sable

UMSTELLUNG
CONVERSION

120 × 278 cm**
Y13440001 051 sand · sable



UMSTELLUNG
CONVERSION

FORMAT FORMAT FORMAT	PREIS PRO PRICE PER PRIX PAR	STÜCK / M ² PIECES / M ² PIÈCES / M ²	KG / M ² KG / M ² KG / M ²	M ² / KARTON M ² / CARTON M ² / CARTON	STK / KARTON PCS / CARTON PCS / CARTON	KG / KARTON KG / CARTON KG / CARTON	M ² / PALETTE M ² / PALLET M ² / PALLETTE	STK / PALETTE PCS / PALLET PCS / PALLETTE	KG / PALETTE KG / PALLET KG / PALLETTE
120 × 278 cm (2778 × 1198 × 6 mm)	M ²	0,2998	14,0906	3,3356	1	47,0000	60,0400	18	846,0000
100 × 100 cm (997 × 997 × 6 mm)	M ²	1,0000	13,8000	2,0000	2	27,6000	50,0000	50	690,0000
60 × 60 cm (598 × 598 × 6 mm)	M ²	2,7778	13,6112	1,4400	4	19,6000	63,3595	176	862,4000

** Sonderformat - Beachten Sie die Verpackungsinformationen · Special size - notice the packaging information
Format spécial - veuillez noter les informations relatives à l'emballage: Seite · Page 136

120 × 278 120 × 120 60 × 120
100 × 100 100 × 100 60 × 60



5 × 5 cm (30 × 30 cm)

Mosaik · Mosaic · Mosaïque

147

Y69202001 sand · sable

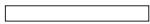

7 × 60 cm

Socket · Plinth · Plinthe

159

Y69201001 sand · sable



30 × 60 cm

Stufe Rille · Step Groove · Marche Rainure

133

Y69203001 sand · sable

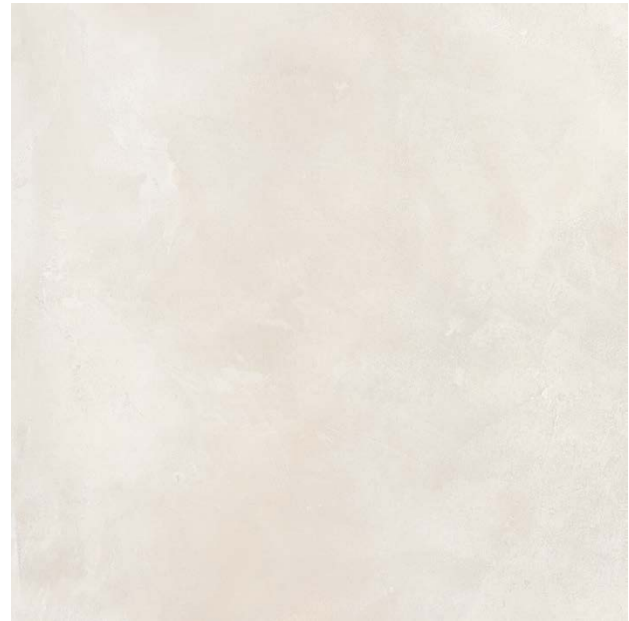

120 × 120 cm**

Y13170001 055 sand · sable

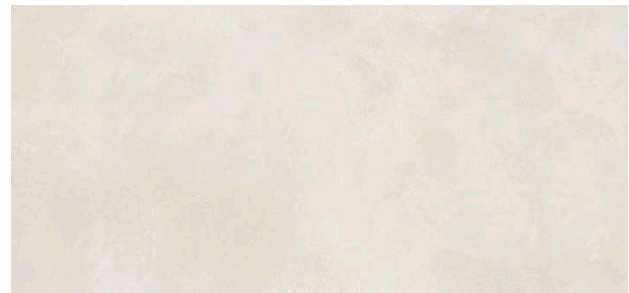

60 × 120 cm**

Y14025101 079 sand · sable

FORMAT FORMAT FORMAT	PREIS PRO PRICE PER PRIX PAR	STÜCK / M ² PIECES / M ² PIÈCES / M ²	KG / M ² KG / M ² KG / M ²	M ² / KARTON M ² / CARTON M ² / CARTON	STK / KARTON PCS / CARTON PCS / CARTON	KG / KARTON KG / CARTON KG / CARTON	M ² / PALETTE M ² / PALLET M ² / PALETTE	STK / PALETTE PCS / PALLET PCS / PALETTE	KG / PALETTE KG / PALLET KG / PALLETTE
120 × 120 cm (1198 × 1198 × 6 mm)	M ²	0,6944	14,0963	2,8802	2	40,6000	69,1244	48	974,4000
60 × 120 cm (1198 × 598 × 6 mm)	M ²	1,3889	14,6529	1,4400	2	21,1000	63,3595	88	928,4000
5 × 5 cm (48 × 48 × 6 mm)	STK · PCS	11,1110	13,8888	1,4400	16	20,0000	-	-	-
7 × 60 cm (598 × 70 × 6 mm)	STK · PCS	1,6667*	1,0167*	9,5998*	16	9,7600	-	-	-
30 × 60 cm (598 × 298 × 6 mm)	STK · PCS	1,6667*	4,0501*	5,9999*	10	24,3000	-	-	-

* Pro lfm · Per m · Par mètre courant

Auftragsfertigung - Lieferzeit beachten · Commissioned production - notice delivery time
Production sur commande - veuillez noter le délai de livraison

NEU
NEW
NEUF

HOLMEN

120 × 278 100 × 100 60 × 60
120 × 120 60 × 120



NEU
NEW
NEUF



100 × 100 cm

Y12625001 066 greige · grège



60 × 60 cm



Y69205001 057 greige · grège

UMSTELLUNG
CONVERSION

120 × 278 cm** 
Y13445001 051 greige · grège



UMSTELLUNG
CONVERSION

FORMAT FORMAT FORMAT	PREIS PRO PRICE PER PRIX PAR	STÜCK / M ² PIECES / M ² PIÈCES / M ²	KG / M ² KG / M ² KG / M ²	M ² / KARTON M ² / CARTON M ² / CARTON	STK / KARTON PCS / CARTON PCS / CARTON	KG / KARTON KG / CARTON KG / CARTON	M ² / PALETTE M ² / PALLET M ² / PALETTE	STK / PALETTE PCS / PALLET PCS / PALLETTE	KG / PALETTE KG / PALLET KG / PALETTE
120 × 278 cm (2778 × 1198 × 6 mm)	 M ²	0,2998	14,0906	3,3356	1	47,0000	60,0400	18	846,0000
100 × 100 cm (997 × 997 × 6 mm)	 M ²	1,0000	13,8000	2,0000	2	27,6000	50,0000	50	690,0000
60 × 60 cm (598 × 598 × 6 mm)	 M ²	2,7778	13,6112	1,4400	4	19,6000	63,3595	176	862,4000

** Sonderformat - Beachten Sie die Verpackungsinformationen · Special size - notice the packaging information
Format spécial - veuillez noter les informations relatives à l'emballage: Seite · Page 136



5 × 5 cm (30 × 30 cm)

Mosaik · Mosaic · Mosaïque

147

Y69207001 greige · grège

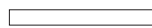

7 × 60 cm

Socket · Plinth · Plinthe

159

Y69206001 greige · grège



30 × 60 cm

Stufe Rille · Step Groove · Marche Rainure

133

Y69208001 greige · grège

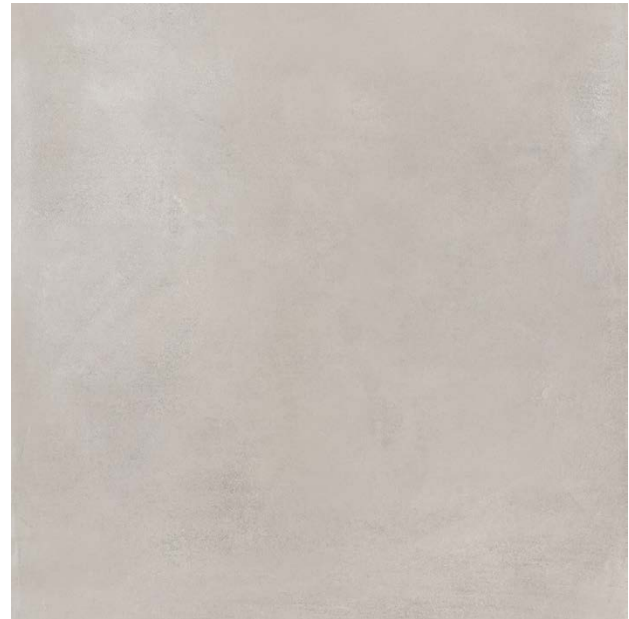

120 × 120 cm**

Y13175001 055 greige · grège



60 × 120 cm**

Y14030101 079 greige · grège

FORMAT FORMAT FORMAT	PREIS PRO PRICE PER PRIX PAR	STÜCK / M ² PIECES / M ² PIÈCES / M ²	KG / M ² KG / M ² KG / M ²	M ² / KARTON M ² / CARTON M ² / CARTON	STK / KARTON PCS / CARTON PCS / CARTON	KG / KARTON KG / CARTON KG / CARTON	M ² / PALETTE M ² / PALLET M ² / PALETTE	STK / PALETTE PCS / PALLET PCS / PALETTE	KG / PALETTE KG / PALLET KG / PALLETTE
120 × 120 cm (1198 × 1198 × 6 mm)	M ²	0,6944	14,0963	2,8802	2	40,6000	69,1244	48	974,4000
60 × 120 cm (1198 × 598 × 6 mm)	M ²	1,3889	14,6529	1,4400	2	21,1000	63,3595	88	928,4000
5 × 5 cm (48 × 48 × 6 mm)	STK · PCS	11,1110	13,8888	1,4400	16	20,0000	-	-	-
7 × 60 cm (598 × 70 × 6 mm)	STK · PCS	1,6667*	1,0167*	9,5998*	16	9,7600	-	-	-
30 × 60 cm (598 × 298 × 6 mm)	STK · PCS	1,6667*	4,0501*	5,9999*	10	24,3000	-	-	-

* Pro lfm · Per m · Par mètre courant

Auftragsfertigung - Lieferzeit beachten · Commissioned production - notice delivery time
Production sur commande - veuillez noter le délai de livraison



HOLMEN

120 × 278 100 × 100 60 × 60
120 × 120 60 × 120



NEU
NEW
NEUF



100 × 100 cm
Y12630001 066 taupe



60 × 60 cm
Y69210001 057 taupe

UMSTELLUNG
CONVERSION

120 × 278 cm**
Y13450001 051 taupe



UMSTELLUNG
CONVERSION

FORMAT FORMAT FORMAT	PREIS PRO PRICE PER PRIX PAR	STÜCK / M ² PIECES / M ² PIÈCES / M ²	KG / M ² KG / M ² KG / M ²	M ² / KARTON M ² / CARTON M ² / CARTON	STK / KARTON PCS / CARTON PCS / CARTON	KG / KARTON KG / CARTON KG / CARTON	M ² / PALETTE M ² / PALLET M ² / PALETTE	STK / PALETTE PCS / PALLET PCS / PALLETTE	KG / PALETTE KG / PALLET KG / PALLETTE
120 × 278 cm (2778 × 1198 × 6 mm)	M ²	0,2998	14,0906	3,3356	1	47,0000	60,0400	18	846,0000
100 × 100 cm (997 × 997 × 6 mm)	M ²	1,0000	13,8000	2,0000	2	27,6000	50,0000	50	690,0000
60 × 60 cm (598 × 598 × 6 mm)	M ²	2,7778	13,6112	1,4400	4	19,6000	63,3595	176	862,4000

** Sonderformat - Beachten Sie die Verpackungsinformationen - Special size - notice the packaging information
Format spécial - veuillez noter les informations relatives à l'emballage: Seite · Page 136

120 × 278 120 × 120 60 × 120
100 × 100 100 × 100 60 × 60



5 × 5 cm (30 × 30 cm)

Mosaik · Mosaic · Mosaïque

147

Y69212001 taupe



7 × 60 cm

Socket · Plinth · Plinthe

159

Y69211001 taupe



30 × 60 cm

Stufe Rille · Step Groove · Marche Rainure

133

Y69213001 taupe



120 × 120 cm**

Y13180001 055 taupe



60 × 120 cm**

Y14035101 079 taupe

FORMAT FORMAT FORMAT	PREIS PRO PRICE PER PRIX PAR	STÜCK / M ² PIECES / M ² PIÈCES / M ²	KG / M ² KG / M ² KG / M ²	M ² / KARTON M ² / CARTON M ² / CARTON	STK / KARTON PCS / CARTON PCS / CARTON	KG / KARTON KG / CARTON KG / CARTON	M ² / PALETTE M ² / PALLET M ² / PALETTE	STK / PALETTE PCS / PALLET PCS / PALETTE	KG / PALETTE KG / PALLET KG / PALETTE
120 × 120 cm (1198 × 1198 × 6 mm)	M ²	0,6944	14,0963	2,8802	2	40,6000	69,1244	48	974,4000
60 × 120 cm (1198 × 598 × 6 mm)	M ²	1,3889	14,6529	1,4400	2	21,1000	63,3595	88	928,4000
5 × 5 cm (48 × 48 × 6 mm)	STK · PCS	11,1110	13,8888	1,4400	16	20,0000	-	-	-
7 × 60 cm (598 × 70 × 6 mm)	STK · PCS	1,6667*	1,0167*	9,5998*	16	9,7600	-	-	-
30 × 60 cm (598 × 298 × 6 mm)	STK · PCS	1,6667*	4,0501*	5,9999*	10	24,3000	-	-	-

* Pro lfm · Per m · Par mètre courant



Auftragsfertigung - Lieferzeit beachten · Commissioned production - notice delivery time
Production sur commande - veuillez noter le délai de livraison

HOLMEN

120 × 278 100 × 100 60 × 60
120 × 120 60 × 120



NEU
NEW
NEUF

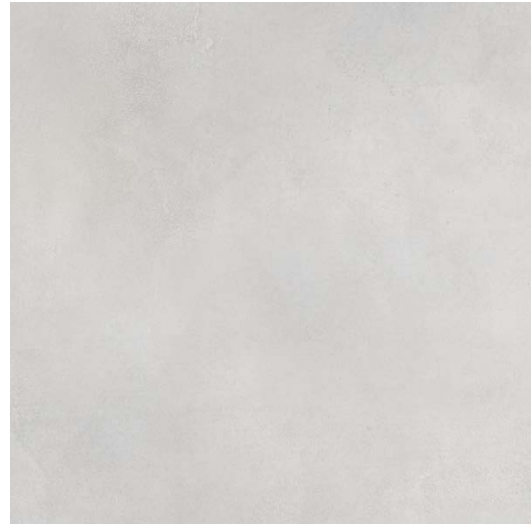

100 × 100 cm

Y12635001 066 zement · cement · ciment



60 × 60 cm

Y69215001 057 zement · cement · ciment

UMSTELLUNG
CONVERSION

120 × 278 cm**



Y13455001 051 zement · cement · ciment



UMSTELLUNG
CONVERSION

FORMAT FORMAT FORMAT	PREIS PRO PRICE PER PRIX PAR	STÜCK / M ² PIECES / M ² PIÈCES / M ²	KG / M ² KG / M ² KG / M ²	M ² / KARTON M ² / CARTON M ² / CARTON	STK / KARTON PCS / CARTON PCS / CARTON	KG / KARTON KG / CARTON KG / CARTON	M ² / PALETTE M ² / PALLETTE M ² / PALLETTE	STK / PALETTE PCS / PALLETTE PCS / PALLETTE	KG / PALETTE KG / PALLETTE KG / PALLETTE
120 × 278 cm (2778 × 1198 × 6 mm)	M ²	0,2998	14,0906	3,3356	1	47,0000	60,0400	18	846,0000
100 × 100 cm (997 × 997 × 6 mm)	M ²	1,0000	13,8000	2,0000	2	27,6000	50,0000	50	690,0000
60 × 60 cm (598 × 598 × 6 mm)	M ²	2,7778	13,6112	1,4400	4	19,6000	63,3595	176	862,4000

** Sonderformat - Beachten Sie die Verpackungsinformationen · Special size - notice the packaging information
Format spécial - veuillez noter les informations relatives à l'emballage: Seite · Page 136



5 × 5 cm (30 × 30 cm)

Mosaik · Mosaic · Mosaïque

147

Y69217001 zement · cement · ciment

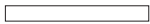

7 × 60 cm

Socket · Plinth · Plinthe

159

Y69216001 zement · cement · ciment



30 × 60 cm

Stufe Rille · Step Groove · Marche Rainure

133

Y69218001 zement · cement · ciment



NEU
NEW
NEUF

120 × 120 cm**

Y13185001 055 zement · cement · ciment



60 × 120 cm**

Y14040101 079 zement · cement · ciment

FORMAT FORMAT FORMAT	PREIS PRO PRICE PER PRIX PAR	STÜCK / M ² PIECES / M ² PIÈCES / M ²	KG / M ² KG / M ² KG / M ²	M ² / KARTON M ² / CARTON M ² / CARTON	STK / KARTON PCS / CARTON PCS / CARTON	KG / KARTON KG / CARTON KG / CARTON	M ² / PALETTE M ² / PALLET M ² / PALETTE	STK / PALETTE PCS / PALLET PCS / PALETTE	KG / PALETTE KG / PALLET KG / PALLETTE
120 × 120 cm (1198 × 1198 × 6 mm)	M ²	0,6944	14,0963	2,8802	2	40,6000	69,1244	48	974,4000
60 × 120 cm (1198 × 598 × 6 mm)	M ²	1,3889	14,6529	1,4400	2	21,1000	63,3595	88	928,4000
5 × 5 cm (48 × 48 × 6 mm)	STK · PCS	11,1110	13,8888	1,4400	16	20,0000	-	-	-
7 × 60 cm (598 × 70 × 6 mm)	STK · PCS	1,6667*	1,0167*	9,5998*	16	9,7600	-	-	-
30 × 60 cm (598 × 298 × 6 mm)	STK · PCS	1,6667*	4,0501*	5,9999*	10	24,3000	-	-	-

* Pro lfm · Per m · Par mètre courant

Auftragsfertigung - Lieferzeit beachten · Commissioned production - notice delivery time
Production sur commande - veuillez noter le délai de livraison



60 × 120 cm

Y66050001 067 kreide · chalk · craie



60 × 60 cm

Y62260001 056 kreide · chalk · craie

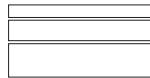

4,8/9,8/14,8 × 60 cm (30 × 60 cm)

Grundfliese 3-teilig · Plain tile 3 pieces · Uni 3 pièces

093

Y62261001 kreide · chalk · craie



5 × 5 cm (30 × 30 cm)

Mosaik · Mosaic · Mosaïque

091

Y62262001 kreide · chalk · craie

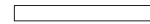

7 × 60 cm

Socket · Plinth · Plinthe

159

Y62263101 kreide · chalk · craie



FORMAT FORMAT FORMAT	PREIS PRO PRICE PER PRIX PAR	STÜCK / M ² PIECES / M ² PIÈCES / M ²	KG / M ² KG / M ² KG / M ²	M ² / KARTON M ² / CARTON M ² / CARTON	STK / KARTON PCS / CARTON PCS / CARTON	KG / KARTON KG / CARTON KG / CARTON	M ² / PALETTE M ² / PALLET M ² / PALETTE	STK / PALETTE PCS / PALLET PCS / PALETTE	KG / PALETTE KG / PALLET KG / PALLET
60 × 120 cm (1198 × 598 × 8 mm)	M ²	1,3889	18,5000	2,1600	3	39,9597	58,3150	81	1.078,9200
60 × 60 cm (598 × 598 × 8 mm)	M ²	2,7778	17,4000	1,4400	4	25,0558	51,8360	144	902,0160
4,8/9,8/14,8 × 60 cm (598 × 298 × 8 mm)	M ²	5,5555	18,3330	1,0800	6	19,7998	25,9180	144	475,2000
5 × 5 cm (48 × 48 × 8 mm)	M ²	11,1110	18,8890	0,9900	11	18,7003	29,7000	330	561,0000
7 × 60 cm (598 × 70 × 8 mm)	STK · PCS	1,6667*	1,2035*	5,9999*	10	7,2210	-	-	-

* Pro lfm · Per m · Par mètre courant



60 × 120 cm

Y66055001 067 sand · sable



60 × 60 cm

Y62265001 056 sand · sable

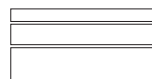

4,8/9,8/14,8 × 60 cm (30 × 60 cm)

Grundfliese 3-teilig · Plain tile 3 pieces · Uni 3 pièces

093

Y62266001 sand · sable



5 × 5 cm (30 × 30 cm)

Mosaik · Mosaic · Mosaïque

091

Y62267001 sand · sable



7 × 60 cm

Socket · Plinth · Plinthe

159

Y62268101 sand · sable



FORMAT FORMAT FORMAT	PREIS PRO PRICE PER PRIX PAR	STÜCK / M ² PIECES / M ² PIÈCES / M ²	KG / M ² KG / M ² KG / M ²	M ² / KARTON M ² / CARTON M ² / CARTON	STK / KARTON PCS / CARTON PCS / CARTON	KG / KARTON KG / CARTON KG / CARTON	M ² / PALETTE M ² / PALLET M ² / PALETTE	STK / PALETTE PCS / PALLET PCS / PALLETTE	KG / PALETTE KG / PALLET KG / PALLETTE
60 × 120 cm (1198 × 598 × 8 mm)	M ²	1,3889	18,5000	2,1600	3	39,9597	58,3150	81	1.078,9200
60 × 60 cm (598 × 598 × 8 mm)	M ²	2,7778	17,4000	1,4400	4	25,0558	51,8360	144	902,0160
4,8/9,8/14,8 × 60 cm (598 × 298 × 8 mm)	M ²	5,5555	18,3330	1,0800	6	19,7998	25,9180	144	475,2000
5 × 5 cm (48 × 48 × 8 mm)	M ²	11,1110	18,8890	0,9900	11	18,7003	29,7000	330	561,0000
7 × 60 cm (598 × 70 × 8 mm)	STK · PCS	1,6667*	1,2035*	5,9999*	10	7,2210	-	-	-

* Pro lfm · Per m · Par mètre courant



60 × 120 cm

Y66060001 067 granit · granite



60 × 60 cm

Y62270001 056 granit · granite

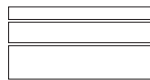

4,8/9,8/14,8 × 60 cm (30 × 60 cm)

Grundfliese 3-teilig · Plain tile 3 pieces · Uni 3 pièces

093

Y62271001 granit · granite



5 × 5 cm (30 × 30 cm)

Mosaik · Mosaic · Mosaique

091

Y62272001 granit · granite

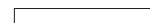

7 × 60 cm

Socket · Plinth · Plinthe

159

Y62273101 granit · granite



FORMAT FORMAT FORMAT	PREIS PRO PRICE PER PRIX PAR	STÜCK / M ² PIECES / M ² PIÈCES / M ²	KG / M ² KG / M ² KG / M ²	M ² / KARTON M ² / CARTON M ² / CARTON	STK / KARTON PCS / CARTON PCS / CARTON	KG / KARTON KG / CARTON KG / CARTON	M ² / PALETTE M ² / PALLET M ² / PALETTE	STK / PALETTE PCS / PALLET PCS / PALETTE	KG / PALETTE KG / PALLET KG / PALLET
60 × 120 cm (1198 × 598 × 8 mm)	M ²	1,3889	18,5000	2,1600	3	39,9597	58,3150	81	1.078,9200
60 × 60 cm (598 × 598 × 8 mm)	M ²	2,7778	17,4000	1,4400	4	25,0558	51,8360	144	902,0160
4,8/9,8/14,8 × 60 cm (598 × 298 × 8 mm)	M ²	5,5555	18,3330	1,0800	6	19,7998	25,9180	144	475,2000
5 × 5 cm (48 × 48 × 8 mm)	M ²	11,1110	18,8890	0,9900	11	18,7003	29,7000	330	561,0000
7 × 60 cm (598 × 70 × 8 mm)	STK · PCS	1,6667*	1,2035*	5,9999*	10	7,2210	-	-	-

* Pro lfm · Per m · Par mètre courant



60 × 120 cm

Y66065001 067 anthrazit · anthracite



60 × 60 cm

Y62275001 056 anthrazit · anthracite

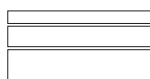

4,8/9,8/14,8 × 60 cm (30 × 60 cm)

Grundfliese 3-teilig · Plain tile 3 pieces · Uni 3 pièces

093

Y62276001 anthrazit · anthracite



5 × 5 cm (30 × 30 cm)

Mosaik · Mosaic · Mosaïque

091

Y62277001 anthrazit · anthracite



7 × 60 cm

Socket · Plinth · Plinthe

159

Y62278101 anthrazit · anthracite



FORMAT FORMAT FORMAT	PREIS PRO PRICE PER PRIX PAR	STÜCK / M ² PIECES / M ² PIÈCES / M ²	KG / M ² KG / M ² KG / M ²	M ² / KARTON M ² / CARTON M ² / CARTON	STK / KARTON PCS / CARTON PCS / CARTON	KG / KARTON KG / CARTON KG / CARTON	M ² / PALETTE M ² / PALLET M ² / PALETTE	STK / PALETTE PCS / PALLET PCS / PALETTE	KG / PALETTE KG / PALLET KG / PALETTE
60 × 120 cm (1198 × 598 × 8 mm)	M ²	1,3889	18,5000	2,1600	3	39,9597	58,3150	81	1.078,9200
60 × 60 cm (598 × 598 × 8 mm)	M ²	2,7778	17,4000	1,4400	4	25,0558	51,8360	144	902,0160
4,8/9,8/14,8 × 60 cm (598 × 298 × 8 mm)	M ²	5,5555	18,3330	1,0800	6	19,7998	25,9180	144	475,2000
5 × 5 cm (48 × 48 × 8 mm)	M ²	11,1110	18,8890	0,9900	11	18,7003	29,7000	330	561,0000
7 × 60 cm (598 × 70 × 8 mm)	STK · PCS	1,6667*	1,2035*	5,9999*	10	7,2210	-	-	-

* Pro lfm · Per m · Par mètre courant

HYGGE

120 × 260
120 × 120

60 × 120
60 × 60



60 × 60 cm

Y69090001 060 kiesel · pebble · galets

120 × 260 cm**

Y13390001 085 kiesel · pebble · galets



FORMAT FORMAT FORMAT	PREIS PRO PRICE PER PRIX PAR	STÜCK / M ² PIECES / M ² PIÈCES / M ²	KG / M ² KG / M ² KG / M ²	M ² / KARTON M ² / CARTON M ² / CARTON	STK / KARTON PCS / CARTON PCS / CARTON	KG / KARTON KG / CARTON KG / CARTON	M ² / PALETTE M ² / PALLET M ² / PALETTE	STK / PALETTE PCS / PALLET PCS / PALETTE	KG / PALETTE KG / PALLET KG / PALLETTE
120 × 260 cm (2598 × 1198 × 6 mm)	M ²	0,3205	13,6084	3,1201	1	42,4600	62,4025	20	849,2000
60 × 60 cm (598 × 598 × 6 mm)	M ²	2,7778	13,6112	1,4400	4	19,6000	63,3595	176	862,4000

** Sonderformat - Beachten Sie die Verpackungsinformationen · Special size - notice the packaging information
Format spécial - veuillez noter les informations relatives à l'emballage: Seite · Page 136



5 × 5 cm (30 × 30 cm)

Mosaik · Mosaic · Mosaïque

147

Y69092001 kiesel · pebble · galets

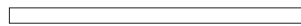

7 × 120 cm

Sockel · Plinth · Plinthe

145

Y13411101 kiesel · pebble · galets



7 × 60 cm

Sockel · Plinth · Plinthe

159

Y69091101 kiesel · pebble · galets

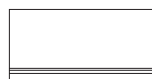

30 × 60 cm

Stufe Rille · Step Groove · Marche Rainure

133

Y69093001 kiesel · pebble · galets



120 × 120 cm**

Y13410101 054 kiesel · pebble · galets



60 × 120 cm**

Y13490101 072 kiesel · pebble · galets

FORMAT FORMAT FORMAT	PREIS PRO PRICE PER PRIX PAR	STÜCK / M ² PIECES / M ² PIÈCES / M ²	KG / M ² KG / M ² KG / M ²	M ² / KARTON M ² / CARTON M ² / CARTON	STK / KARTON PCS / CARTON PCS / CARTON	KG / KARTON KG / CARTON KG / CARTON	M ² / PALETTE M ² / PALLET M ² / PALLETTE	STK / PALETTE PCS / PALLET PCS / PALETTE	KG / PALETTE KG / PALLET KG / PALETTE
120 × 120 cm (1198 × 1198 × 6 mm)	M ²	0,6944	13,8186	2,8802	2	39,8000	69,1244	48	955,2000
60 × 120 cm (1198 × 598 × 6 mm)	M ²	1,3889	13,6112	1,4400	2	19,6000	63,3595	88	862,4000
5 × 5 cm (48 × 48 × 6 mm)	STK · PCS	11,1110	12,6110	1,4400	16	18,1600	-	-	-
7 × 120 cm (1198 × 70 × 6 mm)	STK · PCS	0,8333*	0,9489*	12,0005*	10	11,3870	-	-	-
7 × 60 cm (598 × 70 × 6 mm)	STK · PCS	1,6667*	0,9489*	9,5998*	16	9,1088	-	-	-
30 × 60 cm (598 × 298 × 6 mm)	STK · PCS	1,6667*	4,0501*	5,9999*	10	24,3000	-	-	-

* Pro lfm · Per m · Par mètre courant



Auftragsfertigung - Lieferzeit beachten

Commissioned production - notice delivery time

Production sur commande - veuillez noter le délai de livraison

HYGGE

120 × 260 60 × 120
120 × 120 60 × 60



60 × 60 cm
Y69085001 060 clay

120 × 260 cm**
Y13385001 085 clay



FORMAT FORMAT FORMAT	PREIS PRO PRICE PER PRIX PAR	STÜCK / M ² PIECES / M ² PIÈCES / M ²	KG / M ² KG / M ² KG / M ²	M ² / KARTON M ² / CARTON M ² / CARTON	STK / KARTON PCS / CARTON PCS / CARTON	KG / KARTON KG / CARTON KG / CARTON	M ² / PALETTE M ² / PALLET M ² / PALETTE	STK / PALETTE PCS / PALLET PCS / PALLETTE	KG / PALETTE KG / PALLET KG / PALLETTE
120 × 260 cm (2598 × 1198 × 6 mm)	M ²	0,3205	13,6084	3,1201	1	42,4600	62,4025	20	849,2000
60 × 60 cm (598 × 598 × 6 mm)	M ²	2,7778	13,6112	1,4400	4	19,6000	63,3595	176	862,4000

** Sonderformat - Beachten Sie die Verpackungsinformationen - Special size - notice the packaging information
Format spécial - veuillez noter les informations relatives à l'emballage: Seite · Page 136



5 × 5 cm (30 × 30 cm)

Mosaik · Mosaic · Mosaïque

147

Y69087001 clay



7 × 120 cm

Sockel · Plinth · Plinthe

145

Y13406101 clay



7 × 60 cm

Sockel · Plinth · Plinthe

159

Y69086101 clay



30 × 60 cm

Stufe Rille · Step Groove · Marche Rainure

133

Y69088001 clay



120 × 120 cm**

Y13405101 054 clay



60 × 120 cm**

Y13485101 072 clay

FORMAT FORMAT FORMAT	PREIS PRO PRICE PER PRIX PAR	STÜCK / M ² PIECES / M ² PIÈCES / M ²	KG / M ² KG / M ² KG / M ²	M ² / KARTON M ² / CARTON M ² / CARTON	STK / KARTON PCS / CARTON PCS / CARTON	KG / KARTON KG / CARTON KG / CARTON	M ² / PALETTE M ² / PALLET M ² / PALLETTE	STK / PALETTE PCS / PALLET PCS / PALETTE	KG / PALETTE KG / PALLET KG / PALETTE
120 × 120 cm (1198 × 1198 × 6 mm)	M ²	0,6944	13,8186	2,8802	2	39,8000	69,1244	48	955,2000
60 × 120 cm (1198 × 598 × 6 mm)	M ²	1,3889	13,6112	1,4400	2	19,6000	63,3595	88	862,4000
5 × 5 cm (48 × 48 × 6 mm)	STK · PCS	11,1110	12,6110	1,4400	16	18,1600	-	-	-
7 × 120 cm (1198 × 70 × 6 mm)	STK · PCS	0,8333*	0,9489*	12,0005*	10	11,3870	-	-	-
7 × 60 cm (598 × 70 × 6 mm)	STK · PCS	1,6667*	0,9489*	9,5998*	16	9,1088	-	-	-
30 × 60 cm (598 × 298 × 6 mm)	STK · PCS	1,6667*	4,0501*	5,9999*	10	24,3000	-	-	-

* Pro lfm · Per m · Par mètre courant



Auftragsfertigung - Lieferzeit beachten

Commissioned production - notice delivery time

Production sur commande - veuillez noter le délai de livraison

HYGGE

120 × 260 60 × 120
120 × 120 60 × 60



60 × 60 cm
Y69095001 060 lava

120 × 260 cm**
Y13395001 085 lava



FORMAT FORMAT FORMAT	PREIS PRO PRICE PER PRIX PAR	STÜCK / M ² PIECES / M ² PIÈCES / M ²	KG / M ² KG / M ² KG / M ²	M ² / KARTON M ² / CARTON M ² / CARTON	STK / KARTON PCS / CARTON PCS / CARTON	KG / KARTON KG / CARTON KG / CARTON	M ² / PALETTE M ² / PALLET M ² / PALETTE	STK / PALETTE PCS / PALLET PCS / PALLETTE	KG / PALETTE KG / PALLET KG / PALLETTE
120 × 260 cm (2598 × 1198 × 6 mm)	M ²	0,3205	13,6084	3,1201	1	42,4600	62,4025	20	849,2000
60 × 60 cm (598 × 598 × 6 mm)	M ²	2,7778	13,6112	1,4400	4	19,6000	63,3595	176	862,4000

** Sonderformat - Beachten Sie die Verpackungsinformationen - Special size - notice the packaging information
Format spécial - veuillez noter les informations relatives à l'emballage: Seite · Page 136



5 × 5 cm (30 × 30 cm)

Mosaik · Mosaic · Mosaïque

147

Y69097001 lava

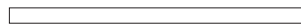

7 × 120 cm

Sockel · Plinth · Plinthe

145

Y13416101 lava



7 × 60 cm

Sockel · Plinth · Plinthe

159

Y69096101 lava



30 × 60 cm

Stufe Rille · Step Groove · Marche Rainure

133

Y69098001 lava



120 × 120 cm**



Y13415101 054 lava



60 × 120 cm**

Y13495101 072 lava

FORMAT FORMAT FORMAT	PREIS PRO PRICE PER PRIX PAR	STÜCK / M ² PIECES / M ² PIÈCES / M ²	KG / M ² KG / M ² KG / M ²	M ² / KARTON M ² / CARTON M ² / CARTON	STK / KARTON PCS / CARTON PCS / CARTON	KG / KARTON KG / CARTON KG / CARTON	M ² / PALETTE M ² / PALLET M ² / PALLETTE	STK / PALETTE PCS / PALLET PCS / PALETTE	KG / PALETTE KG / PALLET KG / PALETTE
120 × 120 cm (1198 × 1198 × 6 mm)	M ²	0,6944	13,8186	2,8802	2	39,8000	69,1244	48	955,2000
60 × 120 cm (1198 × 598 × 6 mm)	M ²	1,3889	13,6112	1,4400	2	19,6000	63,3595	88	862,4000
5 × 5 cm (48 × 48 × 6 mm)	STK · PCS	11,1110	12,6110	1,4400	16	18,1600	-	-	-
7 × 120 cm (1198 × 70 × 6 mm)	STK · PCS	0,8333*	0,9489*	12,0005*	10	11,3870	-	-	-
7 × 60 cm (598 × 70 × 6 mm)	STK · PCS	1,6667*	0,9489*	9,5998*	16	9,1088	-	-	-
30 × 60 cm (598 × 298 × 6 mm)	STK · PCS	1,6667*	4,0501*	5,9999*	10	24,3000	-	-	-

* Pro lfm · Per m · Par mètre courant



Auftragsfertigung - Lieferzeit beachten

Commissioned production - notice delivery time

Production sur commande - veuillez noter le délai de livraison

HYGGE

120 × 260 60 × 120
120 × 120 60 × 60



60 × 60 cm
Y69080001 060 basalt

120 × 260 cm**
Y13380001 085 basalt



FORMAT FORMAT FORMAT	PREIS PRO PRICE PER PRIX PAR	STÜCK / M ² PIECES / M ² PIÈCES / M ²	KG / M ² KG / M ² KG / M ²	M ² / KARTON M ² / CARTON M ² / CARTON	STK / KARTON PCS / CARTON PCS / CARTON	KG / KARTON KG / CARTON KG / CARTON	M ² / PALETTE M ² / PALLET M ² / PALETTE	STK / PALETTE PCS / PALLET PCS / PALETTE	KG / PALETTE KG / PALLET KG / PALETTE
120 × 260 cm (2598 × 1198 × 6 mm)	M ²	0,3205	13,6084	3,1201	1	42,4600	62,4025	20	849,2000
60 × 60 cm (598 × 598 × 6 mm)	M ²	2,7778	13,6112	1,4400	4	19,6000	63,3595	176	862,4000

** Sonderformat - Beachten Sie die Verpackungsinformationen - Special size - notice the packaging information
Format spécial - veuillez noter les informations relatives à l'emballage: Seite · Page 136



5 × 5 cm (30 × 30 cm)

Mosaik · Mosaic · Mosaïque

147

Y69082001 basalt

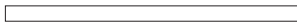

7 × 120 cm

Sockel · Plinth · Plinthe

145

Y13401101 basalt

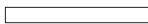

7 × 60 cm

Sockel · Plinth · Plinthe

159

Y69081101 basalt



30 × 60 cm

Stufe Rille · Step Groove · Marche Rainure

133

Y69083001 basalt



120 × 120 cm**

Y13400101 054 basalt



60 × 120 cm**

Y13480101 072 basalt

FORMAT FORMAT FORMAT	PREIS PRO PRICE PER PRIX PAR	STÜCK / M ² PIECES / M ² PIÈCES / M ²	KG / M ² KG / M ² KG / M ²	M ² / KARTON M ² / CARTON M ² / CARTON	STK / KARTON PCS / CARTON PCS / CARTON	KG / KARTON KG / CARTON KG / CARTON	M ² / PALETTE M ² / PALLET M ² / PALLETTE	STK / PALETTE PCS / PALLET PCS / PALETTE	KG / PALETTE KG / PALLET KG / PALETTE
120 × 120 cm (1198 × 1198 × 6 mm)	M ²	0,6944	13,8186	2,8802	2	39,8000	69,1244	48	955,2000
60 × 120 cm (1198 × 598 × 6 mm)	M ²	1,3889	13,6112	1,4400	2	19,6000	63,3595	88	862,4000
5 × 5 cm (48 × 48 × 6 mm)	STK · PCS	11,1110	12,6110	1,4400	16	18,1600	-	-	-
7 × 120 cm (1198 × 70 × 6 mm)	STK · PCS	0,8333*	0,9489*	12,0005*	10	11,3870	-	-	-
7 × 60 cm (598 × 70 × 6 mm)	STK · PCS	1,6667*	0,9489*	9,5998*	16	9,1088	-	-	-
30 × 60 cm (598 × 298 × 6 mm)	STK · PCS	1,6667*	4,0501*	5,9999*	10	24,3000	-	-	-

* Pro lfm · Per m · Par mètre courant



Auftragsfertigung - Lieferzeit beachten

Commissioned production - notice delivery time

Production sur commande - veuillez noter le délai de livraison

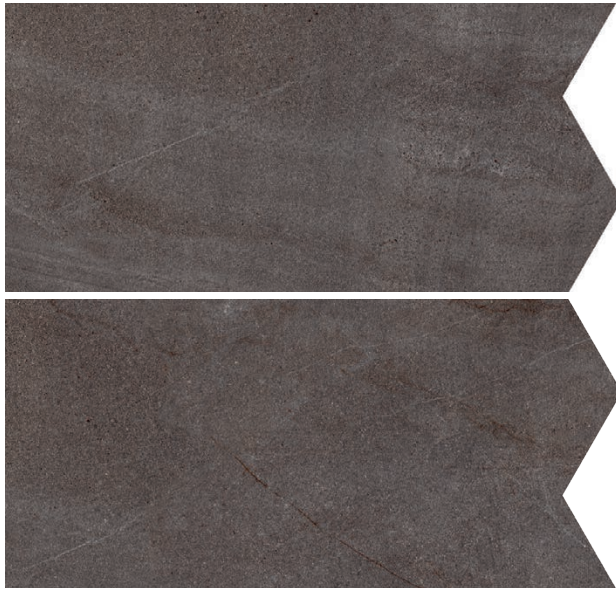

60 × 120 cm**

Y13481001 125 basalt



Schnittdekorset für Sixside, 1 Stück bestehend aus 2 Teilen
 Cut decor set for Sixside, 1 pc. consisting of 2 pieces
 Décor découpe set pour Sixside, 1 pc. composé de 2 pièces



60 × 120 cm**

Y13486001 125 clay



Schnittdekorset für Sixside, 1 Stück bestehend aus 2 Teilen
 Cut decor set for Sixside, 1 pc. consisting of 2 pieces
 Décor découpe set pour Sixside, 1 pc. composé de 2 pièces

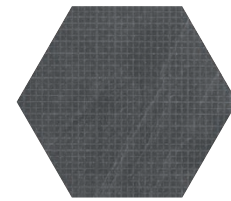
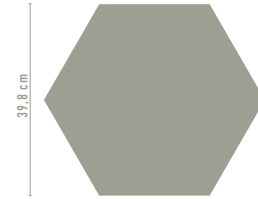

40 × 46 cm

Y12360001 122 diamond



Sixside Dekor · Decor · Décor

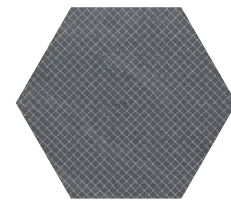

40 × 46 cm

Y12361001 122 square



Sixside Dekor · Decor · Décor

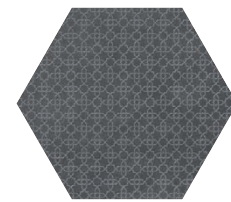

40 × 46 cm

Y12362001 122 mauresk



Sixside Dekor · Decor · Décor

FORMAT FORMAT FORMAT	PREIS PRO PRICE PER PRIX PAR	STÜCK / M ² PIECES / M ² PIÈCES / M ²	KG / M ² KG / M ² KG / M ²	M ² / KARTON M ² / CARTON M ² / CARTON	STK / KARTON PCS / CARTON PCS / CARTON	KG / KARTON KG / CARTON KG / CARTON	M ² / PALETTE M ² / PALLET M ² / PALETTE	STK / PALETTE PCS / PALLET PCS / PALETTE	KG / PALETTE KG / PALLET KG / PALETTE
60 × 120 cm (1198 × 598 × 6 mm)	STK · PCS	0,7331	13,9290	1,3641	1	19,0000	-	-	-
40 × 46 cm	STK · PCS	7,2990	14,5980	1,0960	8	16,0000	-	-	-



40 × 46 cm

Y12363001 129 Hygge kiesel · pebble · galets

Sixside Dekor · Decor · Décor



40 × 46 cm

Y12365001 129 Hygge clay

Sixside Dekor · Decor · Décor

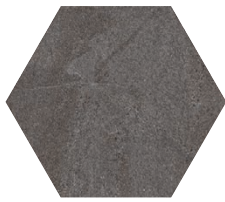

40 × 46 cm

Y12364001 129 Hygge lava

Sixside Dekor · Decor · Décor

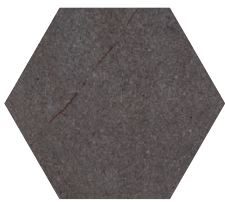

40 × 46 cm

Y12366001 129 Hygge basalt

Sixside Dekor · Decor · Décor



40 × 46 cm

Y12367001 190 gold · or

Sixside Dekor · Decor · Décor



60 × 120 cm**

Y13491001 125 kiesel · pebble · galets

Schnittdekorset für Sixside, 1 Stück bestehend aus 2 Teilen

Cut decor set for Sixside, 1 pc. consisting of 2 pieces

Décor découpe set pour Sixside, 1 pc. composé de 2 pièces

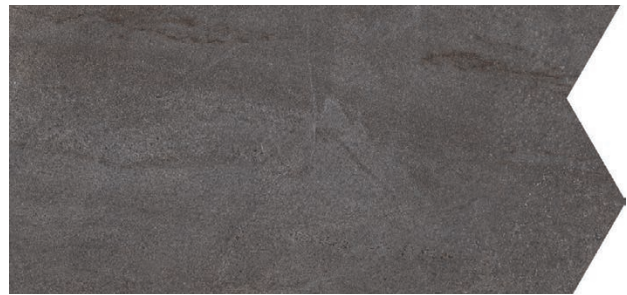

60 × 120 cm**

Y13496001 125 lava

Schnittdekorset für Sixside, 1 Stück bestehend aus 2 Teilen

Cut decor set for Sixside, 1 pc. consisting of 2 pieces

Décor découpe set pour Sixside, 1 pc. composé de 2 pièces



FORMAT FORMAT FORMAT	PREIS PRO PRICE PER PRIX PAR	STÜCK / M ² PIECES / M ² PIÈCES / M ²	KG / M ² KG / M ² KG / M ²	M ² / KARTON M ² / CARTON M ² / CARTON	STK / KARTON PCS / CARTON PCS / CARTON	KG / KARTON KG / CARTON KG / CARTON	M ² / PALETTE M ² / PALLET M ² / PALLETTE	STK / PALETTE PCS / PALLET PCS / PALLETTE	KG / PALETTE KG / PALLET KG / PALLETTE
60 × 120 cm (1198 × 598 × 6 mm)	STK · PCS	0,7331	13,9290	1,3641	1	19,0000	-	-	-
40 × 46 cm	STK · PCS	7,2990	13,8680	1,0960	8	15,2000	-	-	-

Auftragsfertigung - Lieferzeit beachten · Commissioned production - notice delivery time
Production sur commande - veuillez noter le délai de livraison

KALMIT

120 × 260
120 × 120

100 × 100
60 × 120

40 × 120
60 × 60



NEU
NEW
NEUF



5 × 5 cm (30 × 30 cm)
Mosaik · Mosaic · Mosaïque
147

Y13231001 sand · sable

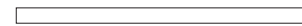

7 × 120 cm
Sockel · Plinth · Plinthe
145

Y13232101 sand · sable

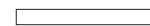

7 × 60 cm
Sockel · Plinth · Plinthe
159

Y13271101 sand · sable



30 × 60 cm
Stufe Rille · Step Groove · Marche Rainure
133

Y13233001 sand · sable



120 × 260 cm**

Y13800001 **085** sand · sable



FORMAT FORMAT FORMAT	PREIS PRO PRICE PER PRIX PAR	STÜCK / M ² PIECES / M ² PIÈCES / M ²	KG / M ² KG / M ² KG / M ²	M ² / KARTON M ² / CARTON M ² / CARTON	STK / KARTON PCS / CARTON PCS / CARTON	KG / KARTON KG / CARTON KG / CARTON	M ² / PALETTE M ² / PALLET M ² / PALETTE	STK / PALETTE PCS / PALLET PCS / PALETTE	KG / PALETTE KG / PALLET KG / PALETTE
120 × 260 cm (2598 × 1198 × 6 mm)	M ²	0,3205	13,6080	3,1201	1	42,4587	62,3050	20	849,2000
5 × 5 cm (48 × 48 × 6 mm)	STK · PCS	11,1110	12,6110	1,4400	16	18,1600	-	-	-
7 × 120 cm (1198 × 70 × 6 mm)	STK · PCS	0,8333*	0,9489*	12,0005*	10	11,3870	-	-	-
7 × 60 cm (598 × 70 × 6 mm)	STK · PCS	1,6667*	0,9489*	9,5998*	16	9,1088	-	-	-
30 × 60 cm (598 × 298 × 6 mm)	STK · PCS	1,6667*	4,0500*	2,4000*	4	9,7200	-	-	-

* Pro lfm · Per m · Par mètre courant

** Sonderformat - Beachten Sie die Verpackungsinformationen - Special size - notice the packaging information
Format spécial - veuillez noter les informations relatives à l'emballage: Seite · Page 136

120 × 260 100 × 100 40 × 120
120 × 120 60 × 120 60 × 60

NEU
NEUF



100 × 100 cm
Y12600001 066 sand · sable



120 × 120 cm**
Y13235101 054 sand · sable



60 × 60 cm
Y13270001 073 sand · sable



60 × 120 cm**
Y13230001 072 sand · sable

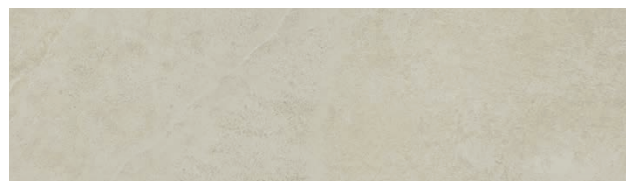

40 × 120 cm**
Y12950001 075 sand · sable

FORMAT FORMAT FORMAT	PREIS PRO PRICE PER PRIX PAR	STÜCK / M ² PIECES / M ² PIÈCES / M ²	KG / M ² KG / M ² KG / M ²	M ² / KARTON M ² / CARTON M ² / CARTON	STK / KARTON PCS / CARTON PCS / CARTON	KG / KARTON KG / CARTON KG / CARTON	M ² / PALETTE M ² / PALLET M ² / PALETTE	STK / PALETTE PCS / PALLET PCS / PALLETTE	KG / PALETTE KG / PALLET KG / PALLETTE
120 × 120 cm (1198 × 1198 × 6 mm)	M ²	0,6944	13,8190	2,8802	2	39,8013	69,1244	48	955,2000
100 × 100 cm (998 × 998 × 6 mm)	M ²	1,0000	13,8000	2,0000	2	27,6000	50,0000	50	690,0000
60 × 120 cm (1198 × 598 × 6 mm)	M ²	1,3889	13,6110	1,4400	2	19,5997	63,3550	88	862,4000
40 × 120 cm (1198 × 398 × 6 mm)	M ²	2,0833	13,6040	1,4400	3	19,5901	64,8100	135	881,5500
60 × 60 cm (598 × 598 × 6 mm)	M ²	2,7778	13,6112	1,4400	4	19,6000	63,3595	176	862,4000



Auftragsfertigung - Lieferzeit beachten

Commissioned production - notice delivery time

Production sur commande - veuillez noter le délai de livraison

KALMIT

120 × 260 100 × 100 40 × 120
120 × 120 60 × 120 60 × 60



NEU
NEW
NEUF



5 × 5 cm (30 × 30 cm)

Mosaik · Mosaic · Mosaïque

147

Y13241001 zement · cement · ciment



7 × 120 cm

Socket · Plinth · Plinthe

145

Y13242101 zement · cement · ciment



7 × 60 cm

Socket · Plinth · Plinthe

159

Y13276101 zement · cement · ciment



30 × 60 cm

Stufe Rille · Step Groove · Marche Rainure

133

Y13243001 zement · cement · ciment



120 × 260 cm**

Y13805001 085 zement · cement · ciment



FORMAT FORMAT FORMAT	PREIS PRO PRICE PER PRIX PAR	STÜCK / M ² PIECES / M ² PIÈCES / M ²	KG / M ² KG / M ² KG / M ²	M ² / KARTON M ² / CARTON M ² / CARTON	STK / KARTON PCS / CARTON PCS / CARTON	KG / KARTON KG / CARTON KG / CARTON	M ² / PALETTE M ² / PALLET M ² / PALETTE	STK / PALETTE PCS / PALLET PCS / PALETTE	KG / PALETTE KG / PALLET KG / PALLET
120 × 260 cm (2598 × 1198 × 6 mm)	M ²	0,3205	13,6080	3,1201	1	42,4587	62,3050	20	849,2000
5 × 5 cm (48 × 48 × 6 mm)	STK · PCS	11,1110	12,6110	1,4400	16	18,1600	-	-	-
7 × 120 cm (1198 × 70 × 6 mm)	STK · PCS	0,8333*	0,9489*	12,0005*	10	11,3870	-	-	-
7 × 60 cm (598 × 70 × 6 mm)	STK · PCS	1,6667*	0,9489*	9,5998*	16	9,1088	-	-	-
30 × 60 cm (598 × 298 × 6 mm)	STK · PCS	1,6667*	4,0500*	2,4000*	4	9,7200	-	-	-

* Pro lfm · Per m · Par mètre courant

** Sonderformat - Beachten Sie die Verpackungsinformationen · Special size - notice the packaging information
Format spécial - veuillez noter les informations relatives à l'emballage: Seite · Page 136

120 × 260 100 × 100 40 × 120
120 × 120 60 × 120 60 × 60

NEU
NEW
NEUF



100 × 100 cm

Y12605001 066 zement · cement · ciment



120 × 120 cm**

Y13245101 054 zement · cement · ciment



60 × 60 cm

Y13275001 073 zement · cement · ciment



60 × 120 cm**

Y13240001 072 zement · cement · ciment

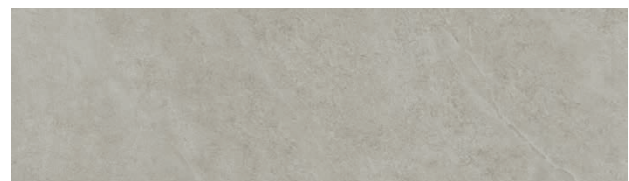

40 × 120 cm**

Y12955001 075 zement · cement · ciment

FORMAT FORMAT FORMAT	PREIS PRO PRICE PER PRIX PAR	STÜCK / M ² PIECES / M ² PIÈCES / M ²	KG / M ² KG / M ² KG / M ²	M ² / KARTON M ² / CARTON M ² / CARTON	STK / KARTON PCS / CARTON PCS / CARTON	KG / KARTON KG / CARTON KG / CARTON	M ² / PALETTE M ² / PALLET M ² / PALLETTE	STK / PALETTE PCS / PALLET PCS / PALETTE	KG / PALETTE KG / PALLET KG / PALETTE
120 × 120 cm (1198 × 1198 × 6 mm)	M ²	0,6944	13,8190	2,8802	2	39,8013	69,1244	48	955,2000
100 × 100 cm (998 × 998 × 6 mm)	M ²	1,0000	13,8000	2,0000	2	27,6000	50,0000	50	690,0000
60 × 120 cm (1198 × 598 × 6 mm)	M ²	1,3889	13,6110	1,4400	2	19,5997	63,3550	88	862,4000
40 × 120 cm (1198 × 398 × 6 mm)	M ²	2,0833	13,6040	1,4400	3	19,5901	64,8100	135	881,5500
60 × 60 cm (598 × 598 × 6 mm)	M ²	2,7778	13,6112	1,4400	4	19,6000	63,3595	176	862,4000



Auftragsfertigung - Lieferzeit beachten

Commissioned production - notice delivery time

Production sur commande - veuillez noter le délai de livraison

KALMIT

120 × 260 100 × 100 40 × 120
120 × 120 60 × 120 60 × 60



NEU
NEW
NEUF



5 × 5 cm (30 × 30 cm)

Mosaik · Mosaic · Mosaïque

147

Y13251001 taupe



7 × 120 cm

Sockel · Plinth · Plinthe

145

Y13252101 taupe



7 × 60 cm

Sockel · Plinth · Plinthe

159

Y13281101 taupe



30 × 60 cm

Stufe Rille · Step Groove · Marche Rainure

133

Y13253001 taupe



120 × 260 cm**

Y13810001 085 taupe



FORMAT FORMAT FORMAT	PREIS PRO PRICE PER PRIX PAR	STÜCK / M ² PIECES / M ² PIÈCES / M ²	KG / M ² KG / M ² KG / M ²	M ² / KARTON M ² / CARTON M ² / CARTON	STK / KARTON PCS / CARTON PCS / CARTON	KG / KARTON KG / CARTON KG / CARTON	M ² / PALETTE M ² / PALLET M ² / PALETTE	STK / PALETTE PCS / PALLET PCS / PALETTE	KG / PALETTE KG / PALLET KG / PALETTE
120 × 260 cm (2598 × 1198 × 6 mm)	M ²	0,3205	13,6080	3,1201	1	42,4587	62,3050	20	849,2000
5 × 5 cm (48 × 48 × 6 mm)	STK · PCS	11,1110	12,6110	1,4400	16	18,1600	-	-	-
7 × 120 cm (1198 × 70 × 6 mm)	STK · PCS	0,8333*	0,9489*	12,0005*	10	11,3870	-	-	-
7 × 60 cm (598 × 70 × 6 mm)	STK · PCS	1,6667*	0,9489*	9,5998*	16	9,1088	-	-	-
30 × 60 cm (598 × 298 × 6 mm)	STK · PCS	1,6667*	4,0500*	2,4000*	4	9,7200	-	-	-

* Pro lfm · Per m · Par mètre courant

** Sonderformat - Beachten Sie die Verpackungsinformationen · Special size - notice the packaging information
Format spécial - veuillez noter les informations relatives à l'emballage: Seite · Page 136

120 × 260 100 × 100 40 × 120
120 × 120 60 × 120 60 × 60

NEU
NEW
NEUF



100 × 100 cm
Y12610001 066 taupe



120 × 120 cm**
Y13255101 054 taupe



60 × 60 cm
Y13280001 073 taupe

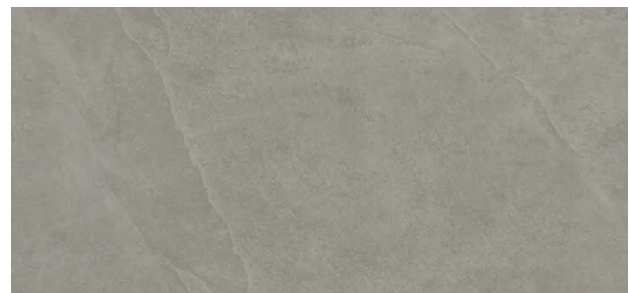

60 × 120 cm**
Y13250001 072 taupe

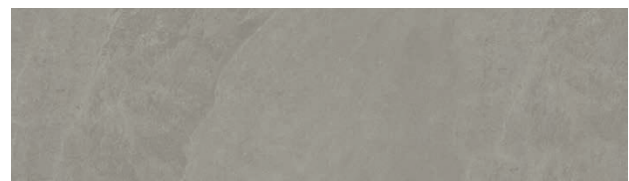

40 × 120 cm**
Y12960001 075 taupe

FORMAT FORMAT FORMAT	PREIS PRO PRICE PER PRIX PAR	STÜCK / M ² PIECES / M ² PIÈCES / M ²	KG / M ² KG / M ² KG / M ²	M ² / KARTON M ² / CARTON M ² / CARTON	STK / KARTON PCS / CARTON PCS / CARTON	KG / KARTON KG / CARTON KG / CARTON	M ² / PALETTE M ² / PALLET M ² / PALETTE	STK / PALETTE PCS / PALLET PCS / PALLETTE	KG / PALETTE KG / PALLET KG / PALLETTE
120 × 120 cm (1198 × 1198 × 6 mm)	M ²	0,6944	13,8190	2,8802	2	39,8013	69,1244	48	955,2000
100 × 100 cm (998 × 998 × 6 mm)	M ²	1,0000	13,8000	2,0000	2	27,6000	50,0000	50	690,0000
60 × 120 cm (1198 × 598 × 6 mm)	M ²	1,3889	13,6110	1,4400	2	19,5997	63,3550	88	862,4000
40 × 120 cm (1198 × 398 × 6 mm)	M ²	2,0833	13,6040	1,4400	3	19,5901	64,8100	135	881,5500
60 × 60 cm (598 × 598 × 6 mm)	M ²	2,7778	13,6112	1,4400	4	19,6000	63,3595	176	862,4000

Auftragsfertigung - Lieferzeit beachten
Commissioned production - notice delivery time
Production sur commande - veuillez noter le délai de livraison

KALMIT

120 × 260 100 × 100 40 × 120
120 × 120 60 × 120 60 × 60



NEU
NEW
NEUF



5 × 5 cm (30 × 30 cm)

Mosaik · Mosaic · Mosaïque

147

Y13261001 grafit · graphite



7 × 120 cm

Socket · Plinth · Plinthe

145

Y13262101 grafit · graphite



7 × 60 cm

Socket · Plinth · Plinthe

159

Y13286101 grafit · graphite



30 × 60 cm

Stufe Rille · Step Groove · Marche Rainure

133

Y13263001 grafit · graphite



120 × 260 cm**

Y13815001 085 grafit · graphite



FORMAT FORMAT FORMAT	PREIS PRO PRICE PER PRIX PAR	STÜCK / M ² PIECES / M ² PIÈCES / M ²	KG / M ² KG / M ² KG / M ²	M ² / KARTON M ² / CARTON M ² / CARTON	STK / KARTON PCS / CARTON PCS / CARTON	KG / KARTON KG / CARTON KG / CARTON	M ² / PALETTE M ² / PALLET M ² / PALETTE	STK / PALETTE PCS / PALLET PCS / PALETTE	KG / PALETTE KG / PALLET KG / PALETTE
120 × 260 cm (2598 × 1198 × 6 mm)	M ²	0,3205	13,6080	3,1201	1	42,4587	62,3050	20	849,2000
5 × 5 cm (48 × 48 × 6 mm)	STK · PCS	11,1110	12,6110	1,4400	16	18,1600	-	-	-
7 × 120 cm (1198 × 70 × 6 mm)	STK · PCS	0,8333*	0,9489*	12,0005*	10	11,3870	-	-	-
7 × 60 cm (598 × 70 × 6 mm)	STK · PCS	1,6667*	0,9489*	9,5998*	16	9,1088	-	-	-
30 × 60 cm (598 × 298 × 6 mm)	STK · PCS	1,6667*	4,0500*	2,4000*	4	9,7200	-	-	-

* Pro lfm · Per m · Par mètre courant

** Sonderformat - Beachten Sie die Verpackungsinformationen · Special size - notice the packaging information
Format spécial - veuillez noter les informations relatives à l'emballage: Seite · Page 136

120 × 260 100 × 100 40 × 120
120 × 120 60 × 120 60 × 60

NEU
NEW
NEUF

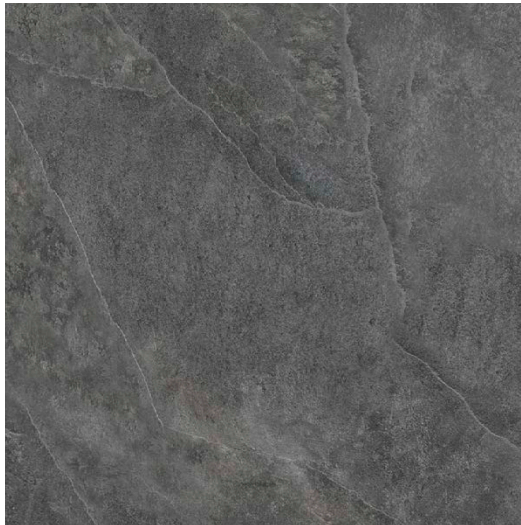

100 × 100 cm

Y12615001 066 grafit · graphite



120 × 120 cm**

Y13265101 054 grafit · graphite



60 × 60 cm

Y13285001 073 grafit · graphite



60 × 120 cm**

Y13260001 072 grafit · graphite

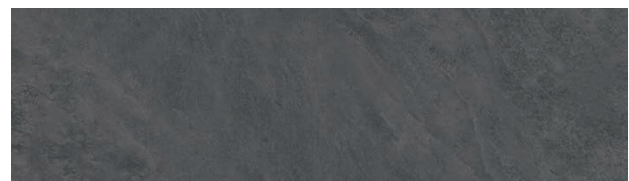

40 × 120 cm**

Y12965001 075 grafit · graphite

FORMAT FORMAT FORMAT	PREIS PRO PRICE PER PRIX PAR	STÜCK / M ² PIECES / M ² PIÈCES / M ²	KG / M ² KG / M ² KG / M ²	M ² / KARTON M ² / CARTON M ² / CARTON	STK / KARTON PCS / CARTON PCS / CARTON	KG / KARTON KG / CARTON KG / CARTON	M ² / PALETTE M ² / PALLET M ² / PALETTE	STK / PALETTE PCS / PALLET PCS / PALETTE	KG / PALETTE KG / PALLET KG / PALETTE
120 × 120 cm (1198 × 1198 × 6 mm)	M ²	0,6944	13,8190	2,8802	2	39,8013	69,1244	48	955,2000
100 × 100 cm (998 × 998 × 6 mm)	M ²	1,0000	13,8000	2,0000	2	27,6000	50,0000	50	690,0000
60 × 120 cm (1198 × 598 × 6 mm)	M ²	1,3889	13,6110	1,4400	2	19,5997	63,3550	88	862,4000
40 × 120 cm (1198 × 398 × 6 mm)	M ²	2,0833	13,6040	1,4400	3	19,5901	64,8100	135	881,5500
60 × 60 cm (598 × 598 × 6 mm)	M ²	2,7778	13,6112	1,4400	4	19,6000	63,3595	176	862,4000



Auftragsfertigung - Lieferzeit beachten

Commissioned production - notice delivery time

Production sur commande - veuillez noter le délai de livraison



120 × 260 cm**

Y13335001 090 macchiato



FORMAT FORMAT FORMAT	PREIS PRO PRICE PER PRIX PAR	STÜCK / M ² PIECES / M ² PIÈCES / M ²	KG / M ² KG / M ² KG / M ²	M ² / KARTON M ² / CARTON M ² / CARTON	STK / KARTON PCS / CARTON PCS / CARTON	KG / KARTON KG / CARTON KG / CARTON	M ² / PALETTE M ² / PALLET M ² / PALETTE	STK / PALETTE PCS / PALLET PCS / PALETTE	KG / PALETTE KG / PALLET KG / PALETTE
120 × 260 cm (2598 × 1198 × 6 mm)	M ²	0,3205	13,6080	3,1201	1	42,4587	62,3050	20	849,2000



5 × 5 cm (30 × 30 cm)

Mosaik · Mosaic · Mosaïque

147

Y13306001 macchiato

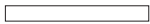

7 × 60 cm

Sockel · Plinth · Plinthe

159

Y13307101 macchiato



120 × 120 cm**

Y13320101 093 macchiato



60 × 120 cm**

Y13305001 054 macchiato

FORMAT FORMAT FORMAT	PREIS PRO PRICE PER PRIX PAR	STÜCK / M ² PIECES / M ² PIÈCES / M ²	KG / M ² KG / M ² KG / M ²	M ² / KARTON M ² / CARTON M ² / CARTON	STK / KARTON PCS / CARTON PCS / CARTON	KG / KARTON KG / CARTON KG / CARTON	M ² / PALETTE M ² / PALLET M ² / PALETTE	STK / PALETTE PCS / PALLET PCS / PALLETTE	KG / PALETTE KG / PALLET KG / PALLETTE
120 × 120 cm (1198 × 1198 × 6 mm)	M ²	0,6944	13,8190	2,8802	2	39,8013	69,1244	48	955,2000
60 × 120 cm (1198 × 598 × 6 mm)	M ²	1,3889	13,6110	1,4400	2	19,5997	63,3550	88	862,4000
5 × 5 cm (48 × 48 × 6 mm)	STK · PCS	11,1110	12,6110	1,4400	16	18,1600	-	-	-
7 × 60 cm (598 × 70 × 6 mm)	STK · PCS	1,6667*	0,9489*	9,5998*	16	9,1088	-	-	-

* Pro lfm · Per m · Par mètre courant

KOLLEKTION_M

120 × 260 120 × 120 60 × 120



120 × 260 cm**

Y13345001 090 earl grey



FORMAT FORMAT FORMAT	PREIS PRO PRICE PER PRIX PAR	STÜCK / M ² PIECES / M ² PIÈCES / M ²	KG / M ² KG / M ² KG / M ²	M ² / KARTON M ² / CARTON M ² / CARTON	STK / KARTON PCS / CARTON PCS / CARTON	KG / KARTON KG / CARTON KG / CARTON	M ² / PALETTE M ² / PALLET M ² / PALETTE	STK / PALETTE PCS / PALLET PCS / PALETTE	KG / PALETTE KG / PALLET KG / PALETTE
120 × 260 cm (2598 × 1198 × 6 mm)	M ²	0,3205	13,6080	3,1201	1	42,4587	62,3050	20	849,2000



5 × 5 cm (30 × 30 cm)

Mosaik · Mosaic · Mosaïque

147

Y13316001 earl grey

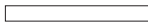

7 × 60 cm

Sockel · Plinth · Plinthe

159

Y13317101 earl grey



120 × 120 cm**

Y13330101 093 earl grey

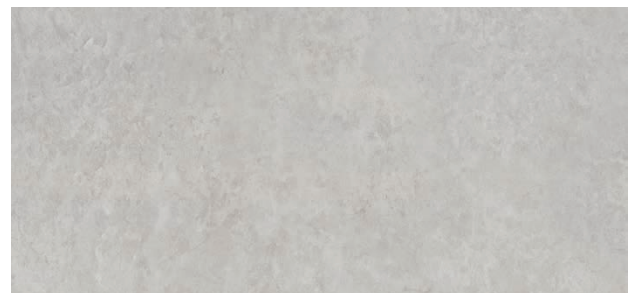

60 × 120 cm**

Y13315001 054 earl grey

FORMAT FORMAT FORMAT	PREIS PRO PRICE PER PRIX PAR	STÜCK / M ² PIECES / M ² PIÈCES / M ²	KG / M ² KG / M ² KG / M ²	M ² / KARTON M ² / CARTON M ² / CARTON	STK / KARTON PCS / CARTON PCS / CARTON	KG / KARTON KG / CARTON KG / CARTON	M ² / PALETTE M ² / PALLET M ² / PALETTE	STK / PALETTE PCS / PALLET PCS / PALLETTE	KG / PALETTE KG / PALLET KG / PALLETTE
120 × 120 cm (1198 × 1198 × 6 mm)	M ²	0,6944	13,8190	2,8802	2	39,8013	69,1244	48	955,2000
60 × 120 cm (1198 × 598 × 6 mm)	M ²	1,3889	13,6110	1,4400	2	19,5997	63,3550	88	862,4000
5 × 5 cm (48 × 48 × 6 mm)	STK · PCS	11,1110	12,6110	1,4400	16	18,1600	-	-	-
7 × 60 cm (598 × 70 × 6 mm)	STK · PCS	1,6667*	0,9489*	9,5998*	16	9,1088	-	-	-

* Pro lfm · Per m · Par mètre courant

KOLLEKTION_M

120 × 260 120 × 120 60 × 120



120 × 260 cm**

Y13340001 090 crema



FORMAT FORMAT FORMAT	PREIS PRO PRICE PER PRIX PAR	STÜCK / M ² PIECES / M ² PIÈCES / M ²	KG / M ² KG / M ² KG / M ²	M ² / KARTON M ² / CARTON M ² / CARTON	STK / KARTON PCS / CARTON PCS / CARTON	KG / KARTON KG / CARTON KG / CARTON	M ² / PALETTE M ² / PALLET M ² / PALETTE	STK / PALETTE PCS / PALLET PCS / PALETTE	KG / PALETTE KG / PALLET KG / PALETTE
120 × 260 cm (2598 × 1198 × 6 mm)	M ²	0,3205	13,6080	3,1201	1	42,4587	62,3050	20	849,2000



5 × 5 cm (30 × 30 cm)

Mosaik · Mosaic · Mosaïque

147

Y13311001 crema

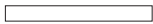

7 × 60 cm

Sockel · Plinth · Plinthe

159

Y13312101 crema



120 × 120 cm**

Y13325101 093 crema



60 × 120 cm**

Y13310001 054 crema

FORMAT FORMAT FORMAT	PREIS PRO PRICE PER PRIX PAR	STÜCK / M ² PIECES / M ² PIÈCES / M ²	KG / M ² KG / M ² KG / M ²	M ² / KARTON M ² / CARTON M ² / CARTON	STK / KARTON PCS / CARTON PCS / CARTON	KG / KARTON KG / CARTON KG / CARTON	M ² / PALETTE M ² / PALLET M ² / PALETTE	STK / PALETTE PCS / PALLET PCS / PALLETTE	KG / PALETTE KG / PALLET KG / PALLETTE
120 × 120 cm (1198 × 1198 × 6 mm)	M ²	0,6944	13,8190	2,8802	2	39,8013	69,1244	48	955,2000
60 × 120 cm (1198 × 598 × 6 mm)	M ²	1,3889	13,6110	1,4400	2	19,5997	63,3550	88	862,4000
5 × 5 cm (48 × 48 × 6 mm)	STK · PCS	11,1110	12,6110	1,4400	16	18,1600	-	-	-
7 × 60 cm (598 × 70 × 6 mm)	STK · PCS	1,6667*	0,9489*	9,5998*	16	9,1088	-	-	-

* Pro lfm · Per m · Par mètre courant

LIMESTONE

75 × 75 37,5 × 75



75 × 75 cm

Y75175001 075 beige



37,5 × 75 cm

Y74175001 067 beige

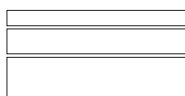

6 / 12,3 / 18,6 × 75 cm (37,5 × 75 cm)

Grundfliese 3-teilig · Plain tile 3 pieces · Uni 3 pièces

053

Y75178001 beige



7 × 75 cm

Sockel · Plinth · Plinthe

127

Y75176101 beige



37,5 × 75 cm

Stufe Rille · Step Groove · Marche Rainure

149

Y75177001 beige

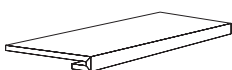

33 × 75 cm

Stufe · Step · Marche

100

Y75275001 beige

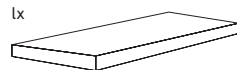

33 × 75 cm

Stufe links · Step left · Marche à gauche

179

Y75276001 beige



33 × 75 cm

Stufe rechts · Step right · Marche à droite

179

Y75277001 beige



FORMAT FORMAT FORMAT	PREIS PRO PRICE PER PRIX PAR	STÜCK / M ² PIECES / M ² PIÈCES / M ²	KG / M ² KG / M ² KG / M ²	M ² / KARTON M ² / CARTON M ² / CARTON	STK / KARTON PCS / CARTON PCS / CARTON	KG / KARTON KG / CARTON KG / CARTON	M ² / PALETTE M ² / PALLET M ² / PALETTE	STK / PALETTE PCS / PALLET PCS / PALETTE	KG / PALETTE KG / PALLET KG / PALETTE
75 × 75 cm (748 × 748 × 10 mm)	M ²	1,7778	22,1340	1,1250	2	24,9004	47,2440	84	1.045,8000
37,5 × 75 cm (748 × 373 × 10 mm)	M ²	3,5556	22,0450	1,1250	4	24,8003	26,9970	96	595,2000
6 / 12,3 / 18,6 × 75 cm (748 × 373 × 10 mm)	M ²	3,5556	22,1410	1,1250	4	24,9083	50,6190	180	1.120,8600
7 × 75 cm (748 × 70 × 10 mm)	STK · PCS	1,3333*	1,4933*	7,5002*	10	11,2000	-	-	-
37,5 × 75 cm (748 × 373 × 10 mm)	STK · PCS	1,3333*	8,2664*	3,0000*	4	24,8000	-	-	-
33 × 75 cm (748 × 328 × 35 mm)	STK · PCS	1,3333*	10,2664*	1,5000*	2	15,4000	-	-	-
33 × 75 cm lx/rx (748 × 328 × 35 mm)	STK · PCS	1,3333*	10,6664*	0,7500*	1	8,0000	-	-	-

* Pro lfm · Per m · Par mètre courant



Auftragsfertigung - Lieferzeit beachten

Commissioned production - notice delivery time · Production sur commande - veuillez noter le délai de livraison



75 × 75 cm

Y75180001 075 grau · grey · gris



37,5 × 75 cm

Y74180001 067 grau · grey · gris

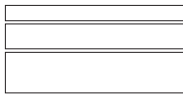

6 / 12,3 / 18,6 × 75 cm (37,5 × 75 cm)

Grundfliese 3-teilig · Plain tile 3 pieces · Uni 3 pièces

053

Y75183001 grau · grey · gris



7 × 75 cm

Sockel · Plinth · Plinthe

127

Y75181101 grau · grey · gris



37,5 × 75 cm

Stufe Rille · Step Groove · Marche Rainure

149

Y75182001 grau · grey · gris



FORMAT FORMAT FORMAT	PREIS PRO PRICE PER PRIX PAR	STÜCK / M ² PIECES / M ² PIÈCES / M ²	KG / M ² KG / M ² KG / M ²	M ² / KARTON M ² / CARTON M ² / CARTON	STK / KARTON PCS / CARTON PCS / CARTON	KG / KARTON KG / CARTON KG / CARTON	M ² / PALETTE M ² / PALLET M ² / PALETTE	STK / PALETTE PCS / PALLET PCS / PALETTE	KG / PALETTE KG / PALLET KG / PALLETTE
75 × 75 cm (748 × 748 × 10 mm)	M ²	1,7778	22,1340	1,1250	2	24,9004	47,2440	84	1.045,8000
37,5 × 75 cm (748 × 373 × 10 mm)	M ²	3,5556	22,0450	1,1250	4	24,8003	26,9970	96	595,2000
6 / 12,3 / 18,6 × 75 cm (748 × 373 × 10 mm)	M ²	3,5556	22,1410	1,1250	4	24,9083	50,6190	180	1.120,8600
7 × 75 cm (748 × 70 × 10 mm)	STK · PCS	1,3333*	1,4933*	7,5002*	10	11,2000	-	-	-
37,5 × 75 cm (748 × 373 × 10 mm)	STK · PCS	1,3333*	8,2664*	3,0000*	4	24,8000	-	-	-

* Pro lfm · Per m · Par mètre courant

LINCOLN

20 × 90,5



20 × 90,5 cm

Y74750001 * birke · birch · bouleau



20 × 90,5 cm

Y74755001 * tanne · fir tree · sapin



20 × 90,5 cm

Y74760001 * buche · beech · hêtre



5 × 5 cm (30 × 30 cm)

Mosaik · Mosaic · Mosaïque

*

Y74754001 birke · birch · bouleau

Y74759001 tanne · fir tree · sapin

Y74764001 buche · beech · hêtre



7 × 90,5 cm

Socket · Plinth · Plinthe

*

Y74751101 birke · birch · bouleau

Y74756101 tanne · fir tree · sapin

Y74761101 buche · beech · hêtre



30 × 90,5 cm

Stufe Rille 2-teilig

Step Groove 2 pieces

Marche Rainure 2 pièces

*

Y74753001 birke · birch · bouleau

Y74758001 tanne · fir tree · sapin

Y74763001 buche · beech · hêtre



FORMAT FORMAT FORMAT	PREIS PRO PRICE PER PRIX PAR	STÜCK / M ² PIECES / M ² PIÈCES / M ²	KG / M ² KG / M ² KG / M ²	M ² / KARTON M ² / CARTON M ² / CARTON	STK / KARTON PCS / CARTON PCS / CARTON	KG / KARTON KG / CARTON KG / CARTON	M ² / PALETTE M ² / PALLET M ² / PALLETTE	STK / PALETTE PCS / PALLETTE PCS / PALLETTE	KG / PALETTE KG / PALLET KG / PALLETTE
20 × 90,5 cm (904 × 199 × 10 mm)	M ²	5,5556	21,9450	1,0800	6	23,7004	38,8770	216	853,2000
5 × 5 cm (48 × 48 × 10 mm)	STK · PCS	11,1110	24,4440	0,9900	11	24,1998	-	-	-
7 × 90,5 cm (904 × 70 × 10 mm)	STK · PCS	1,1050*	1,5835*	4,5249*	5	7,1650	-	-	-
30 × 90,5 cm (904 × 299,5 × 10 mm)	STK · PCS	1,1050*	6,7824*	1,8100*	2	12,2760	-	-	-

* Pro lfm · Per m · Par mètre courant





60 × 120 cm**
Y13350001 072 beige



60 × 60 cm
Y69050001 056 beige



5 × 5 cm (30 × 30 cm)
Mosaik · Mosaic · Mosaïque
147

Y13352001 beige



7 × 120 cm
Socket · Plinth · Plinthe
145

Y13351101 beige



7 × 60 cm
Socket · Plinth · Plinthe
159

Y69051101 beige

FORMAT FORMAT FORMAT	PREIS PRO PRICE PER PRIX PAR	STÜCK / M ² PIECES / M ² PIÈCES / M ²	KG / M ² KG / M ² KG / M ²	M ² / KARTON M ² / CARTON M ² / CARTON	STK / KARTON PCS / CARTON PCS / CARTON	KG / KARTON KG / CARTON KG / CARTON	M ² / PALETTE M ² / PALLET M ² / PALETTE	STK / PALETTE PCS / PALLET PCS / PALLETTE	KG / PALETTE KG / PALLET KG / PALLETTE
60 × 120 cm (1198 × 598 × 6 mm)	M ²	1,3889	14,0280	2,1600	3	30,3002	75,5940	105	1.060,5000
60 × 60 cm (598 × 598 × 6 mm)	M ²	2,7778	14,0280	1,4400	4	20,2002	57,5950	160	808,0000
5 × 5 cm (48 × 48 × 6 mm)	STK · PCS	11,1110	13,8890	1,4400	16	20,0004	-	-	-
7 × 120 cm (1198 × 70 × 6 mm)	STK · PCS	0,8333*	1,0033*	12,0005*	10	12,0400	-	-	-
7 × 60 cm (598 × 70 × 6 mm)	STK · PCS	1,6667*	0,9489*	9,5998*	16	9,1088	-	-	-

* Pro lfm · Per m · Par mètre courant

** Sonderformat - Beachten Sie die Verpackungsinformationen · Special size - notice the packaging information
Format spécial - veuillez noter les informations relatives à l'emballage: Seite · Page 136 gres|steuler



60 × 120 cm**

Y13355001 072 grau · grey · gris



60 × 60 cm

Y69055001 056 grau · grey · gris



5 × 5 cm (30 × 30 cm)

Mosaik · Mosaic · Mosaique

147

Y13357001 grau · grey · gris



7 × 120 cm

Socket · Plinth · Plinthe

145

Y13356101 grau · grey · gris



7 × 60 cm

Socket · Plinth · Plinthe

159

Y69056101 grau · grey · gris



FORMAT FORMAT FORMAT	PREIS PRO PRICE PER PRIX PAR	STÜCK / M ² PIECES / M ² PIÈCES / M ²	KG / M ² KG / M ² KG / M ²	M ² / KARTON M ² / CARTON M ² / CARTON	STK / KARTON PCS / CARTON PCS / CARTON	KG / KARTON KG / CARTON KG / CARTON	M ² / PALETTE M ² / PALLET M ² / PALETTE	STK / PALETTE PCS / PALLET PCS / PALETTE	KG / PALETTE KG / PALLET KG / PALETTE
60 × 120 cm (1198 × 598 × 6 mm)	M ²	1,3889	14,0280	2,1600	3	30,3002	75,5940	105	1.060,5000
60 × 60 cm (598 × 598 × 6 mm)	M ²	2,7778	14,0280	1,4400	4	20,2002	57,5950	160	808,0000
5 × 5 cm (48 × 48 × 6 mm)	STK · PCS	11,1110	13,8890	1,4400	16	20,0004	-	-	-
7 × 120 cm (1198 × 70 × 6 mm)	STK · PCS	0,8333*	1,0033*	12,0005*	10	12,0400	-	-	-
7 × 60 cm (598 × 70 × 6 mm)	STK · PCS	1,6667*	0,9489*	9,5998*	16	9,1088	-	-	-

* Pro lfm · Per m · Par mètre courant

** Sonderformat - Beachten Sie die Verpackungsinformationen · Special size - notice the packaging information
Format spécial - veuillez noter les informations relatives à l'emballage: Seite · Page 136



60 × 120 cm**
Y13360001 072 taupe



60 × 60 cm
Y69060001 056 taupe



5 × 5 cm (30 × 30 cm)
Mosaik · Mosaic · Mosaique
147

Y13362001 taupe



7 × 120 cm
Socket · Plinth · Plinthe
145

Y13361101 taupe



7 × 60 cm
Socket · Plinth · Plinthe
159

Y69061101 taupe



FORMAT FORMAT FORMAT	PREIS PRO PRICE PER PRIX PAR	STÜCK / M ² PIECES / M ² PIÈCES / M ²	KG / M ² KG / M ² KG / M ²	M ² / KARTON M ² / CARTON M ² / CARTON	STK / KARTON PCS / CARTON PCS / CARTON	KG / KARTON KG / CARTON KG / CARTON	M ² / PALETTE M ² / PALLET M ² / PALETTE	STK / PALETTE PCS / PALLET PCS / PALLETTE	KG / PALETTE KG / PALLET KG / PALLETTE
60 × 120 cm (1198 × 598 × 6 mm)	M ²	1,3889	14,0280	2,1600	3	30,3002	75,5940	105	1.060,5000
60 × 60 cm (598 × 598 × 6 mm)	M ²	2,7778	14,0280	1,4400	4	20,2002	57,5950	160	808,0000
5 × 5 cm (48 × 48 × 6 mm)	STK · PCS	11,1110	13,8890	1,4400	16	20,0004	-	-	-
7 × 120 cm (1198 × 70 × 6 mm)	STK · PCS	0,8333*	1,0033*	12,0005*	10	12,0400	-	-	-
7 × 60 cm (598 × 70 × 6 mm)	STK · PCS	1,6667*	0,9489*	9,5998*	16	9,1088	-	-	-

* Pro lfm · Per m · Par mètre courant



60 × 120 cm**

Y13365001 072 blau · blue · bleu



60 × 60 cm

Y69065001 056 blau · blue · bleu



5 × 5 cm (30 × 30 cm)

Mosaik · Mosaic · Mosaïque

147

Y13367001 blau · blue · bleu



7 × 120 cm

Sockel · Plinth · Plinthe

145

Y13366101 blau · blue · bleu



7 × 60 cm

Sockel · Plinth · Plinthe

159

Y69066101 blau · blue · bleu

FORMAT FORMAT FORMAT	PREIS PRO PRICE PER PRIX PAR	STÜCK / M ² PIECES / M ² PIÈCES / M ²	KG / M ² KG / M ² KG / M ²	M ² / KARTON M ² / CARTON M ² / CARTON	STK / KARTON PCS / CARTON PCS / CARTON	KG / KARTON KG / CARTON KG / CARTON	M ² / PALETTE M ² / PALLET M ² / PALETTE	STK / PALETTE PCS / PALLET PCS / PALETTE	KG / PALETTE KG / PALLET KG / PALLETTE
60 × 120 cm (1198 × 598 × 6 mm)	M ²	1,3889	14,0280	2,1600	3	30,3002	75,5940	105	1.060,5000
60 × 60 cm (598 × 598 × 6 mm)	M ²	2,7778	14,0280	1,4400	4	20,2002	57,5950	160	808,0000
5 × 5 cm (48 × 48 × 6 mm)	STK · PCS	11,1110	13,8890	1,4400	16	20,0004	-	-	-
7 × 120 cm (1198 × 70 × 6 mm)	STK · PCS	0,8333*	1,0033*	12,0005*	10	12,0400	-	-	-
7 × 60 cm (598 × 70 × 6 mm)	STK · PCS	1,6667*	0,9489*	9,5998*	16	9,1088	-	-	-

* Pro lfm · Per m · Par mètre courant

** Sonderformat - Beachten Sie die Verpackungsinformationen · Special size - notice the packaging information
Format spécial - veuillez noter les informations relatives à l'emballage: Seite · Page 136



60 × 120 cm**

Y13370001 072 anthrazit · anthracite



60 × 60 cm

Y69070001 056 anthrazit · anthracite



5 × 5 cm (30 × 30 cm)

Mosaik · Mosaic · Mosaïque

147

Y13372001 anthrazit · anthracite



7 × 120 cm

Socket · Plinth · Plinthe

145

Y13371101 anthrazit · anthracite



7 × 60 cm

Socket · Plinth · Plinthe

159

Y69071101 anthrazit · anthracite



FORMAT FORMAT FORMAT	PREIS PRO PRICE PER PRIX PAR	STÜCK / M ² PIECES / M ² PIÈCES / M ²	KG / M ² KG / M ² KG / M ²	M ² / KARTON M ² / CARTON M ² / CARTON	STK / KARTON PCS / CARTON PCS / CARTON	KG / KARTON KG / CARTON KG / CARTON	M ² / PALETTE M ² / PALLET M ² / PALETTE	STK / PALETTE PCS / PALLET PCS / PALETTE	KG / PALETTE KG / PALLET KG / PALLETTE
60 × 120 cm (1198 × 598 × 6 mm)	M ²	1,3889	14,0280	2,1600	3	30,3002	75,5940	105	1.060,5000
60 × 60 cm (598 × 598 × 6 mm)	M ²	2,7778	14,0280	1,4400	4	20,2002	57,5950	160	808,0000
5 × 5 cm (48 × 48 × 6 mm)	STK · PCS	11,1110	13,8890	1,4400	16	20,0004	-	-	-
7 × 120 cm (1198 × 70 × 6 mm)	STK · PCS	0,8333*	1,0033*	12,0005*	10	12,0400	-	-	-
7 × 60 cm (598 × 70 × 6 mm)	STK · PCS	1,6667*	0,9489*	9,5998*	16	9,1088	-	-	-

* Pro lfm · Per m · Par mètre courant



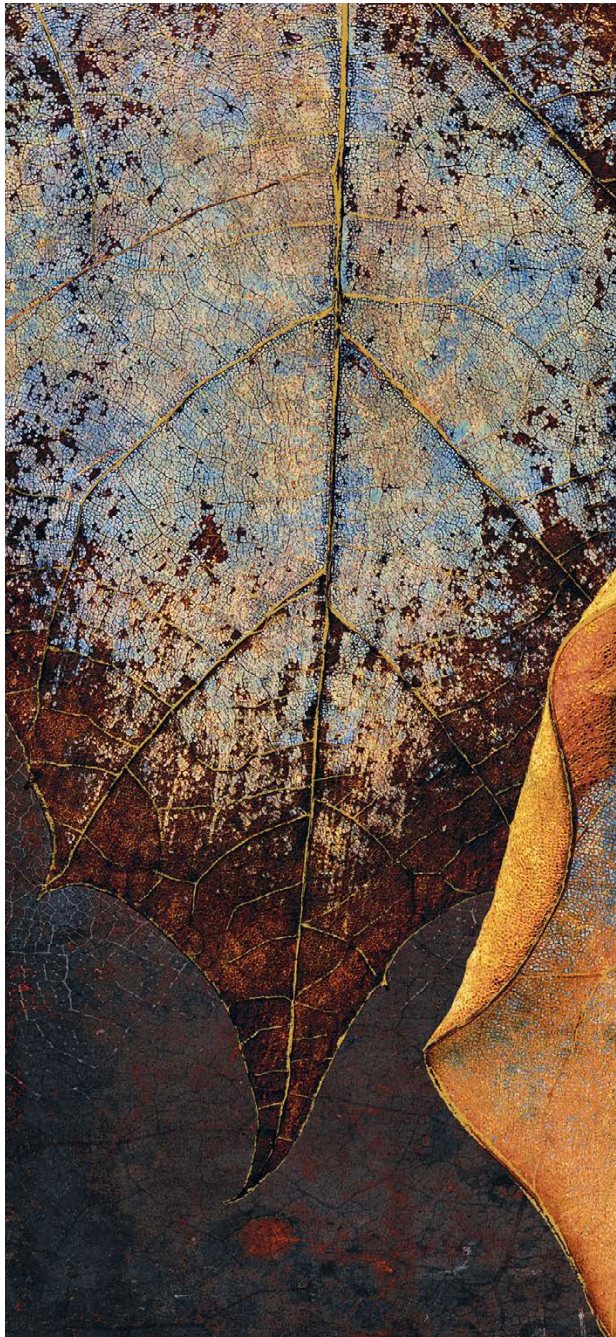

240 × 260 cm**

Y13500001 * autumn



Dekorationsset, 1 Stück bestehend aus 2 Teilen à 120 × 260/06 cm

Decor set, 1 pc. consisting of 2 pieces à 120 × 260/06 cm

Décor set, 1 pc. composé de 2 pièces à 120 × 260/06 cm

FORMAT FORMAT FORMAT	PREIS PRO PRICE PER PRIX PAR	STÜCK / M ² PIECES / M ² PIÈCES / M ²	KG / M ² KG / M ² KG / M ²	M ² / KARTON M ² / CARTON M ² / CARTON	STK / KARTON PCS / CARTON PCS / CARTON	KG / KARTON KG / CARTON KG / CARTON	M ² / PALETTE M ² / PALLET M ² / PALETTE	STK / PALETTE PCS / PALLET PCS / PALLETTE	KG / PALETTE KG / PALLET KG / PALETTE
240 × 260 cm (2598 × 2398 × 6 mm)	 STK · PCS	0,3205	13,6260	6,2383	1	85,0000	-	-	-

* Siehe separates Preisblatt

Please see the separate price list · Voir la liste des prix séparée

SHERWOOD

Feinsteinzeug, durchgefärbt · Porcelain gres, solid-coloured · Grès cérame, coloré
Rektifiziert · Rectified · Rectifié

25 × 150



25 × 150 cm

Y66850001 * sepia



25 × 150 cm

Y66855001 * ginger



25 × 150 cm

Y66860001 * marone · maroon · marron

FORMAT FORMAT FORMAT	PREIS PRO PRICE PER PRIX PAR	STÜCK / M ² PIECES / M ² PIÈCES / M ²	KG / M ² KG / M ² KG / M ²	M ² / KARTON M ² / CARTON M ² / CARTON	STK / KARTON PCS / CARTON PCS / CARTON	KG / KARTON KG / CARTON KG / CARTON	M ² / PALETTE M ² / PALLET M ² / PALETTE	STK / PALETTE PCS / PALLET PCS / PALETTE	KG / PALETTE KG / PALLET KG / PALETTE
25 × 150 cm (1498 × 248 × 10 mm)	M ²	2,6670	22,0028	1,4998	4	33,0000	35,9955	96	792,0000

* Siehe separates Preisblatt
Please see the separate price list · Voir la liste des prix séparée

NEU
NEW
NEUF



NEU
NEW
NEUF



20 × 120 cm

Y74040001 * sepia



20 × 120 cm

Y74045001 * ginger



20 × 120 cm

Y74050001 * marone · maroon · marron

FORMAT FORMAT FORMAT	PREIS PRO PRICE PER PRIX PAR	STÜCK / M ² PIECES / M ² PIÈCES / M ²	KG / M ² KG / M ² KG / M ²	M ² / KARTON M ² / CARTON M ² / CARTON	STK / KARTON PCS / CARTON PCS / CARTON	KG / KARTON KG / CARTON KG / CARTON	M ² / PALETTE M ² / PALLET M ² / PALETTE	STK / PALETTE PCS / PALLET PCS / PALLETTE	KG / PALETTE KG / PALLET KG / PALLETTE
20 × 120 cm (1204 × 204 × 8 mm)	M ²	4,1667	18,5751	1,6800	7	31,2060	40,3197	168	748,9440

* Siehe separates Preisblatt

Please see the separate price list · Voir la liste des prix séparée

SLATE

75 × 75 37,5 × 75 37,5 × 37,5



75 × 75 cm

Y75400001 075 schiefer · slate · gris ardoise

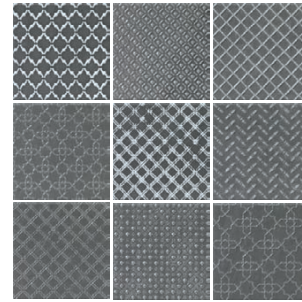

12,5 × 12,5 cm

Y75409001 164

Quadrat dekoriert schiefer · slate · gris ardoise

Dekorationsset, 1 Stück bestehend aus 9 Teilen

Decor set, 1 pc. consisting of 9 pieces

Décor set, 1 pc. composé de 9 pièces

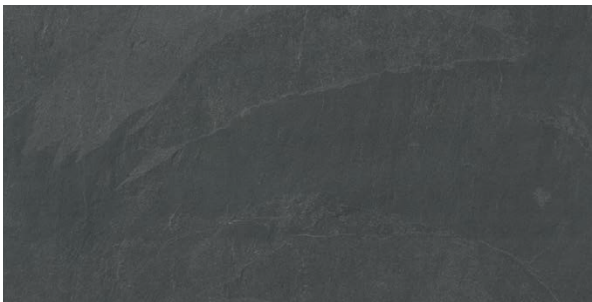

37,5 × 75 cm

Y74400001 063 schiefer · slate · gris ardoise



37,5 × 37,5 cm

Y74405001 058 schiefer · slate · gris ardoise

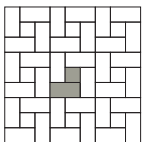

BEISPIELE FÜR FLÄCHENVERLEGUNGEN UND BERECHNUNGEN: SEITE 137

EXAMPLES FOR LAYINGS AND CALCULATIONS: PAGE 137

EXEMPLES POUR SURFACES POSE ET CALCUL: PAGE 137

FORMAT FORMAT FORMAT	PREIS PRO PRICE PER PRIX PAR	STÜCK / M ² PIECES / M ² PIÈCES / M ²	KG / M ² KG / M ² KG / M ²	M ² / KARTON M ² / CARTON M ² / CARTON	STK / KARTON PCS / CARTON PCS / CARTON	KG / KARTON KG / CARTON KG / CARTON	M ² / PALETTE M ² / PALLET M ² / PALLETTE	STK / PALETTE PCS / PALLET PCS / PALLETTE	KG / PALETTE KG / PALLET KG / PALLETTE
75 × 75 cm (748 × 748 × 10 mm)	M ²	1,7778	22,1340	1,1250	2	24,9004	47,2440	84	1.045,8000
37,5 × 75 cm (748 × 373 × 10 mm)	M ²	3,5556	22,0450	1,1250	4	24,8003	26,9970	96	595,2000
37,5 × 37,5 cm (373 × 373 × 10 mm)	M ²	7,0922	21,2770	1,1280	8	24,0005	50,7610	360	1.080,0000
12,5 × 12,5 cm (123 × 123 × 10 mm)**	STK · PCS	8,0000	23,0400	0,1250	1	2,8800	-	-	-

** dekoriert · decorated · décoré



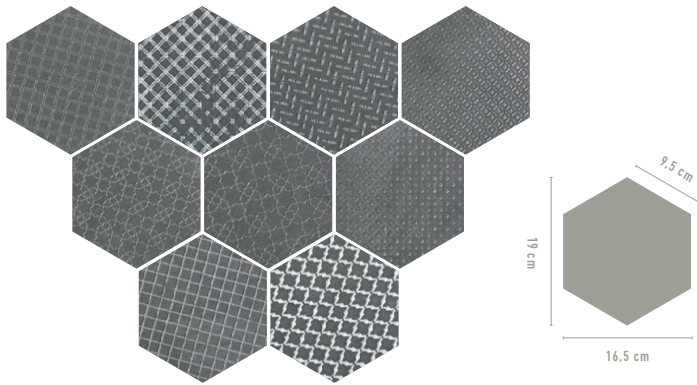

16,5 × 19 cm

Y75408001 168

Sechseck dekoriert schiefer · slate · gris ardoise

Dekorationsset, 1 Stück bestehend aus 9 Teilen

Decor set, 1 pc. consisting of 9 pieces

Décor set, 1 pc. composé de 9 pièces

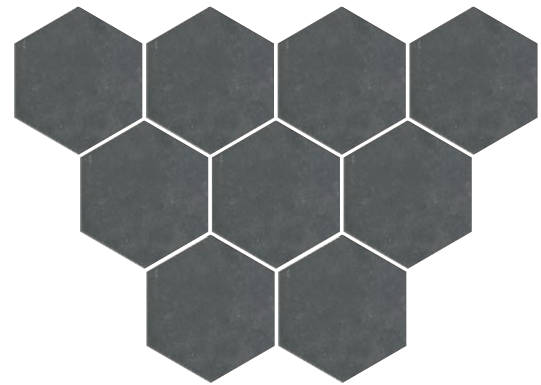

16,5 × 19 cm

Y75410001 110

Sechseck Uni schiefer · slate · gris ardoise

Dekorationsset, 1 Stück bestehend aus 9 Teilen

Decor set, 1 pc. consisting of 9 pieces

Décor set, 1 pc. composé de 9 pièces

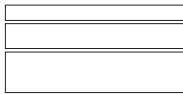

6 / 12,3 / 18,6 × 75 cm (37,5 × 75 cm)

Grundfliese 3-teilig · Plain tile 3 pieces · Uni 3 pièces

053

Y75402001 schiefer · slate · gris ardoise

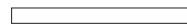

7 × 75 cm

Sockel · Plinth · Plinthe

127

Y75401101 schiefer · slate · gris ardoise



37,5 × 75 cm

Stufe Rille · Step Groove · Marche Rainure

149

Y75403001 schiefer · slate · gris ardoise

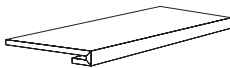

33 × 75 cm

Stufe · Step · Marche

100

Y75404001 schiefer · slate · gris ardoise

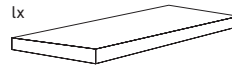

33 × 75 cm

Stufe links · Step left · Marche à gauche

179

Y75405001 schiefer · slate · gris ardoise



33 × 75 cm

Stufe rechts · Step right · Marche à droite

179

Y75406001 schiefer · slate · gris ardoise



FORMAT FORMAT FORMAT	PREIS PRO PRICE PER PRIX PAR	STÜCK / M ² PIECES / M ² PIÈCES / M ²	KG / M ² KG / M ² KG / M ²	M ² / KARTON M ² / CARTON M ² / CARTON	STK / KARTON PCS / CARTON PCS / CARTON	KG / KARTON KG / CARTON KG / CARTON	M ² / PALETTE M ² / PALLET M ² / PALETTE	STK / PALETTE PCS / PALLET PCS / PALLETTE	KG / PALETTE KG / PALLET KG / PALLETTE
6 / 12,3 / 18,6 × 75 cm (748 × 373 × 10 mm)	M ²	3,5556	18,4890	1,1250	4	20,7999	50,6190	180	936,0000
16,5 × 19 cm (188 × 163 × 10 mm)	STK · PCS	4,4440	21,3310	0,2250	1	4,8000	-	-	-
16,5 × 19 cm (188 × 163 × 10 mm)**	STK · PCS	4,4440	22,9310	0,2250	1	5,1600	-	-	-
7 × 75 cm (748 × 70 × 10 mm)	STK · PCS	1,3333*	1,4933*	7,5002*	10	11,2000	-	-	-
37,5 × 75 cm (748 × 373 × 10 mm)	STK · PCS	1,3333*	8,2664*	3,0000*	4	24,8000	-	-	-
33 × 75 cm (748 × 328 × 35 mm)	STK · PCS	1,3333*	10,2664*	1,5000*	2	15,4000	-	-	-
33 × 75 cm lx/rx (748 × 328 × 35 mm)	STK · PCS	1,3333*	10,6664*	0,7500*	1	8,0000	-	-	-

* Pro lfm · Per m · Par mètre courant // ** dekoriert · decorated · décoré

TALO

120 × 260 60 × 120 60 × 60
120 × 120 20 × 120

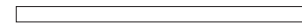

7 × 120 cm
Sockel · Plinth · Plinthe

145

Y14007001 sand · sable

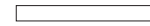

7 × 60 cm
Sockel · Plinth · Plinthe

159

Y69182001 sand · sable



30 × 60 cm
Stufe Rille · Step Groove · Marche Rainure

133

Y69183001 sand · sable



120 × 260 cm**

Y13540001 054 sand · sable



FORMAT FORMAT FORMAT	PREIS PRO PRICE PER PRIX PAR	STÜCK / M ² PIECES / M ² PIÈCES / M ²	KG / M ² KG / M ² KG / M ²	M ² / KARTON M ² / CARTON M ² / CARTON	STK / KARTON PCS / CARTON PCS / CARTON	KG / KARTON KG / CARTON KG / CARTON	M ² / PALETTE M ² / PALLET M ² / PALLETTE	STK / PALETTE PCS / PALLET PCS / PALLETTE	KG / PALETTE KG / PALLET KG / PALLETTE
120 × 260 cm (2598 × 1198 × 6 mm)	M ²	0,3205	13,6084	3,1201	1	42,4600	62,4025	20	849,2000
7 × 120 cm (1198 × 70 × 6 mm)	STK · PCS	0,8333*	0,9489*	12,0005*	10	11,3870	-	-	-
7 × 60 cm (598 × 70 × 6 mm)	STK · PCS	1,6667*	0,9489*	9,5998*	16	9,1088	-	-	-
30 × 60 cm (598 × 298 × 6 mm)	STK · PCS	1,6667*	4,0500*	2,4000*	4	9,7200	-	-	-

* Pro lfm · Per m · Par mètre courant

** Sonderformat - Beachten Sie die Verpackungsinformationen · Special size - notice the packaging information
Format spécial - veuillez noter les informations relatives à l'emballage: Seite · Page 136

120 × 260 120 × 120
60 × 120 20 × 120
60 × 60



60 × 60 cm

Y69180001 060 sand · sable



5 × 5 cm (30 × 30 cm)

Mosaik · Mosaic · Mosaïque

147

Y14006001 sand · sable



120 × 120 cm**

Y13560001 052 sand · sable



60 × 120 cm**

Y14005001 067 sand · sable

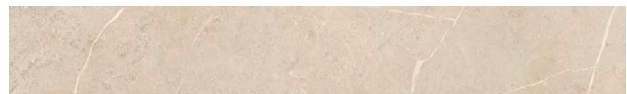

20 × 120 cm**

Y13580001 067 sand · sable

FORMAT FORMAT FORMAT	PREIS PRO PRICE PER PRIX PAR	STÜCK / M ² PIECES / M ² PIÈCES / M ²	KG / M ² KG / M ² KG / M ²	M ² / KARTON M ² / CARTON M ² / CARTON	STK / KARTON PCS / CARTON PCS / CARTON	KG / KARTON KG / CARTON KG / CARTON	M ² / PALETTE M ² / PALLET M ² / PALETTE	STK / PALETTE PCS / PALLET PCS / PALETTE	KG / PALETTE KG / PALLET KG / PALETTE
120 × 120 cm (1198 × 1198 × 6 mm)	M ²	0,6944	13,8186	2,8802	2	39,8000	69,1244	48	955,2000
60 × 120 cm (1198 × 598 × 6 mm)	M ²	1,3889	13,6112	1,4400	2	19,6000	63,3595	88	862,4000
20 × 120 cm (1198 × 198 × 6 mm)	M ²	4,1667	13,5834	1,6800	7	22,8200	50,3996	210	684,6000
60 × 60 cm (598 × 598 × 6 mm)	M ²	2,7778	13,6112	1,4400	4	19,6000	63,3595	176	862,4000
5 × 5 cm (48 × 48 × 6 mm)	STK · PCS	11,1110	12,6110	1,4400	16	18,1600	-	-	-

TALO

120 × 260 60 × 120 60 × 60
120 × 120 20 × 120

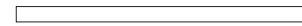

7 × 120 cm
Sockel · Plinth · Plinthe
145

Y14012001 clay

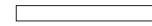

7 × 60 cm
Sockel · Plinth · Plinthe
159

Y69187001 clay



30 × 60 cm
Stufe Rille · Step Groove · Marche Rainure
133

Y69188001 clay



120 × 260 cm**
Y13545001 **054** clay



FORMAT FORMAT FORMAT	PREIS PRO PRICE PER PRIX PAR	STÜCK / M ² PIECES / M ² PIÈCES / M ²	KG / M ² KG / M ² KG / M ²	M ² / KARTON M ² / CARTON M ² / CARTON	STK / KARTON PCS / CARTON PCS / CARTON	KG / KARTON KG / CARTON KG / CARTON	M ² / PALETTE M ² / PALLETTE M ² / PALLETTE	STK / PALETTE PCS / PALLETTE PCS / PALLETTE	KG / PALETTE KG / PALLETTE KG / PALLETTE
120 × 260 cm (2598 × 1198 × 6 mm)	M ²	0,3205	13,6084	3,1201	1	42,4600	62,4025	20	849,2000
7 × 120 cm (1198 × 70 × 6 mm)	STK · PCS	0,8333*	0,9489*	12,0005*	10	11,3870	-	-	-
7 × 60 cm (598 × 70 × 6 mm)	STK · PCS	1,6667*	0,9489*	9,5998*	16	9,1088	-	-	-
30 × 60 cm (598 × 298 × 6 mm)	STK · PCS	1,6667*	4,0500*	2,4000*	4	9,7200	-	-	-

* Pro lfm · Per m · Par mètre courant

** Sonderformat - Beachten Sie die Verpackungsinformationen · Special size - notice the packaging information
Format spécial - veuillez noter les informations relatives à l'emballage: Seite · Page 136

120 × 260 120 × 120 20 × 120
60 × 120 60 × 60



60 × 60 cm
Y69185001 060 clay



5 × 5 cm (30 × 30 cm)
Mosaik · Mosaic · Mosaïque
147
Y14011001 clay



120 × 120 cm**
Y13565001 052 clay



60 × 120 cm**
Y14010001 067 clay

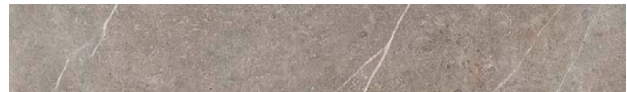

20 × 120 cm**
Y13585001 067 clay

FORMAT FORMAT FORMAT	PREIS PRO PRICE PER PRIX PAR	STÜCK / M ² PIECES / M ² PIÈCES / M ²	KG / M ² KG / M ² KG / M ²	M ² / KARTON M ² / CARTON M ² / CARTON	STK / KARTON PCS / CARTON PCS / CARTON	KG / KARTON KG / CARTON KG / CARTON	M ² / PALETTE M ² / PALLET M ² / PALETTE	STK / PALETTE PCS / PALLET PCS / PALLETTE	KG / PALETTE KG / PALLET KG / PALETTE
120 × 120 cm (1198 × 1198 × 6 mm)	M ²	0,6944	13,8186	2,8802	2	39,8000	69,1244	48	955,2000
60 × 120 cm (1198 × 598 × 6 mm)	M ²	1,3889	13,6112	1,4400	2	19,6000	63,3595	88	862,4000
20 × 120 cm (1198 × 198 × 6 mm)	M ²	4,1667	13,5834	1,6800	7	22,8200	50,3996	210	684,6000
60 × 60 cm (598 × 598 × 6 mm)	M ²	2,7778	13,6112	1,4400	4	19,6000	63,3595	176	862,4000
5 × 5 cm (48 × 48 × 6 mm)	STK · PCS	11,1110	12,6110	1,4400	16	18,1600	-	-	-

TALO

120 × 260 60 × 120 60 × 60
120 × 120 20 × 120

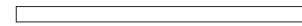

7 × 120 cm
Sockel · Plinth · Plinthe
145

Y14017001 earth

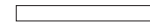

7 × 60 cm
Sockel · Plinth · Plinthe
159

Y69192001 earth



30 × 60 cm
Stufe Rille · Step Groove · Marche Rainure
133

Y69193001 earth



120 × 260 cm**
Y13550001 **054** earth



FORMAT FORMAT FORMAT	PREIS PRO PRICE PER PRIX PAR	STÜCK / M ² PIECES / M ² PIÈCES / M ²	KG / M ² KG / M ² KG / M ²	M ² / KARTON M ² / CARTON M ² / CARTON	STK / KARTON PCS / CARTON PCS / CARTON	KG / KARTON KG / CARTON KG / CARTON	M ² / PALETTE M ² / PALLETTE M ² / PALLETTE	STK / PALETTE PCS / PALLETTE PCS / PALLETTE	KG / PALETTE KG / PALLETTE KG / PALLETTE
120 × 260 cm (2598 × 1198 × 6 mm)	M ²	0,3205	13,6084	3,1201	1	42,4600	62,4025	20	849,2000
7 × 120 cm (1198 × 70 × 6 mm)	STK · PCS	0,8333*	0,9489*	12,0005*	10	11,3870	-	-	-
7 × 60 cm (598 × 70 × 6 mm)	STK · PCS	1,6667*	0,9489*	9,5998*	16	9,1088	-	-	-
30 × 60 cm (598 × 298 × 6 mm)	STK · PCS	1,6667*	4,0500*	2,4000*	4	9,7200	-	-	-

* Pro lfm · Per m · Par mètre courant

** Sonderformat - Beachten Sie die Verpackungsinformationen · Special size - notice the packaging information
Format spécial - veuillez noter les informations relatives à l'emballage: Seite · Page 136

120 × 260 120 × 120 20 × 120
60 × 120 60 × 60



60 × 60 cm
Y69190001 060 earth



5 × 5 cm (30 × 30 cm)
Mosaik · Mosaic · Mosaïque
147

Y14016001 earth



120 × 120 cm**
Y13570001 052 earth



60 × 120 cm**
Y14015001 067 earth



20 × 120 cm**
Y13590001 067 earth

FORMAT FORMAT FORMAT	PREIS PRO PRICE PER PRIX PAR	STÜCK / M ² PIECES / M ² PIÈCES / M ²	KG / M ² KG / M ² KG / M ²	M ² / KARTON M ² / CARTON M ² / CARTON	STK / KARTON PCS / CARTON PCS / CARTON	KG / KARTON KG / CARTON KG / CARTON	M ² / PALETTE M ² / PALLET M ² / PALETTE	STK / PALETTE PCS / PALLET PCS / PALETTE	KG / PALETTE KG / PALLET KG / PALETTE
120 × 120 cm (1198 × 1198 × 6 mm)	M ²	0,6944	13,8186	2,8802	2	39,8000	69,1244	48	955,2000
60 × 120 cm (1198 × 598 × 6 mm)	M ²	1,3889	13,6112	1,4400	2	19,6000	63,3595	88	862,4000
20 × 120 cm (1198 × 198 × 6 mm)	M ²	4,1667	13,5834	1,6800	7	22,8200	50,3996	210	684,6000
60 × 60 cm (598 × 598 × 6 mm)	M ²	2,7778	13,6112	1,4400	4	19,6000	63,3595	176	862,4000
5 × 5 cm (48 × 48 × 6 mm)	STK · PCS	11,1110	12,6110	1,4400	16	18,1600	-	-	-

TALO

120 × 260 60 × 120 60 × 60
120 × 120 20 × 120

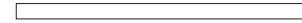

7 × 120 cm
Sockel · Plinth · Plinthe
145

Y14022001 basalt

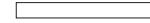

7 × 60 cm
Sockel · Plinth · Plinthe
159

Y69197001 basalt



30 × 60 cm
Stufe Rille · Step Groove · Marche Rainure
133

Y69198001 basalt



120 × 260 cm**
Y13555001 **054** basalt



FORMAT FORMAT FORMAT	PREIS PRO PRICE PER PRIX PAR	STÜCK / M ² PIECES / M ² PIÈCES / M ²	KG / M ² KG / M ² KG / M ²	M ² / KARTON M ² / CARTON M ² / CARTON	STK / KARTON PCS / CARTON PCS / CARTON	KG / KARTON KG / CARTON KG / CARTON	M ² / PALETTE M ² / PALLET M ² / PALETTE	STK / PALETTE PCS / PALLET PCS / PALLETTE	KG / PALETTE KG / PALLET KG / PALLETTE
120 × 260 cm (2598 × 1198 × 6 mm)	M ²	0,3205	13,6084	3,1201	1	42,4600	62,4025	20	849,2000
7 × 120 cm (1198 × 70 × 6 mm)	STK · PCS	0,8333*	0,9489*	12,0005*	10	11,3870	-	-	-
7 × 60 cm (598 × 70 × 6 mm)	STK · PCS	1,6667*	0,9489*	9,5998*	16	9,1088	-	-	-
30 × 60 cm (598 × 298 × 6 mm)	STK · PCS	1,6667*	4,0500*	2,4000*	4	9,7200	-	-	-

* Pro lfm · Per m · Par mètre courant

** Sonderformat - Beachten Sie die Verpackungsinformationen · Special size - notice the packaging information
Format spécial - veuillez noter les informations relatives à l'emballage: Seite · Page 136

120 × 260 120 × 120
60 × 120 20 × 120
60 × 60



60 × 60 cm
Y69195001 060 basalt



5 × 5 cm (30 × 30 cm)
Mosaik · Mosaic · Mosaïque

147

Y14021001 basalt



120 × 120 cm**
Y13575001 052 basalt



60 × 120 cm**
Y14020001 067 basalt



20 × 120 cm**
Y13595001 067 basalt

FORMAT FORMAT FORMAT	PREIS PRO PRICE PER PRIX PAR	STÜCK / M ² PIECES / M ² PIÈCES / M ²	KG / M ² KG / M ² KG / M ²	M ² / KARTON M ² / CARTON M ² / CARTON	STK / KARTON PCS / CARTON PCS / CARTON	KG / KARTON KG / CARTON KG / CARTON	M ² / PALETTE M ² / PALLET M ² / PALETTE	STK / PALETTE PCS / PALLET PCS / PALETTE	KG / PALETTE KG / PALLET KG / PALETTE
120 × 120 cm (1198 × 1198 × 6 mm)	M ²	0,6944	13,8186	2,8802	2	39,8000	69,1244	48	955,2000
60 × 120 cm (1198 × 598 × 6 mm)	M ²	1,3889	13,6112	1,4400	2	19,6000	63,3595	88	862,4000
20 × 120 cm (1198 × 198 × 6 mm)	M ²	4,1667	13,5834	1,6800	7	22,8200	50,3996	210	684,6000
60 × 60 cm (598 × 598 × 6 mm)	M ²	2,7778	13,6112	1,4400	4	19,6000	63,3595	176	862,4000
5 × 5 cm (48 × 48 × 6 mm)	STK · PCS	11,1110	12,6110	1,4400	16	18,1600	-	-	-

INFORMATIONEN

INFORMATION

INFORMATIONS

VERPACKUNGSMITTEL GROSSFORMATE

PACKAGING INFORMATION LARGE FORMATS

INFORMATIONS RELATIVES À L'EMBALLAGE GRANDS FORMATS

TRANSPORTKISTE

TRANSPORT CRATE

CAISSE DE TRANSPORT

* Verpackungspauschale: 170 €

Packaging fee: 170 €

Frais d'emballage: 170 €

max 20 Stück · pieces · pièces

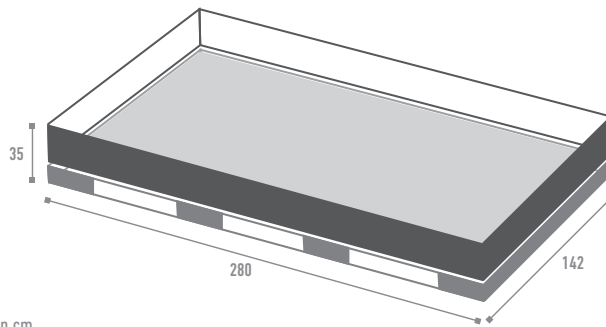

Fliesenmaß

Tile size
Dimension des carreaux

120 × 260 cm

Angaben in cm · Measurements in cm · Mesures in cm



HINWEIS FÜR DEN TRANSPORT UND HANDLING: Bitte verwenden Sie eine Gabelverlängerung auf 1,30 m anstelle der Standard 80 cm langen Gabel und nutzen geeignete Hebehilfen.
NOTE FOR TRANSPORT AND HANDLING: Please use a fork extension to 1.30 m instead of standard 80 cm long fork. Use suitable lifting aids.
NOTE POUR LE TRANSPORT ET MANUTENTION: Veuillez utiliser une rallonge de fourche jusqu'à 1,30 m au lieu d'une fourche standard de 80 cm de long. Utilisez des aides de levage appropriées.

TRANSPORTGESTELL

TRANSPORT RACK

CHÂSSIS DE TRANSPORT

Verpackungspauschale: 170 €

Packaging fee: 170 €

Frais d'emballage: 170 €

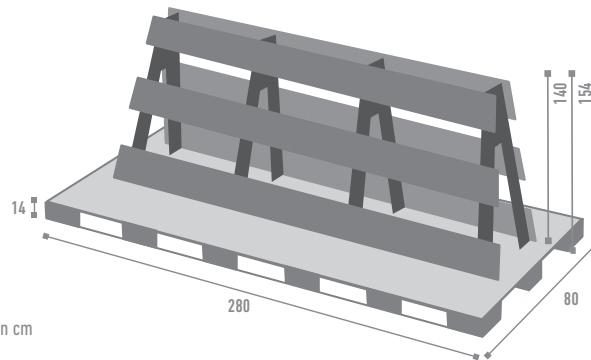

Fliesenmaß

Tile size
Dimension des carreaux

120 × 260 cm

Angaben in cm · Measurements in cm · Mesures in cm

VERSANDGESTELL

SHIPPING RACK

CHÂSSIS D'EXPÉDITION

Verpackungspauschale: 86 €

Packaging fee: 86 €

Frais d'emballage: 86 €

max 16 Stück · pieces · pièces

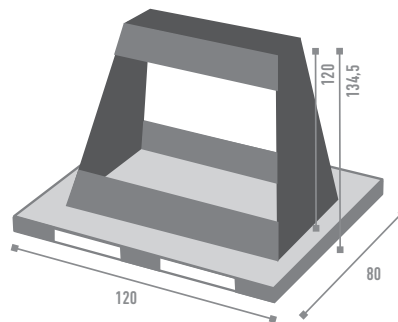

Fliesenmaß

Tile size
Dimension des carreaux

120 × 120 cm
100 × 100 cm

Angaben in cm · Measurements in cm · Mesures in cm

VERSANDHILFE

SHIPPING SUPPORT

SUPPORT D'EXPÉDITION

Die Versandhilfe ist auf einer Europalette leicht fixiert. Die Europalette selbst muss getauscht werden, da sie ansonsten mit 12,50 €/Europalette berechnet wird.

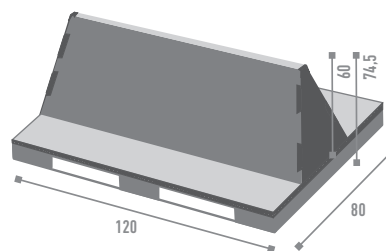

Fliesenmaß

Tile size
Dimension des carreaux

60 × 120 cm
40 × 120 cm
30 × 120 cm
35 × 100 cm

Angaben in cm · Measurements in cm · Mesures in cm

BEISPIELE FÜR FLÄCHENVERLEGUNGEN UND BERECHNUNGEN

EXAMPLES FOR LAYINGS AND CALCULATIONS

EXEMPLES POUR SURFACES POSE ET CALCUL

SLATE

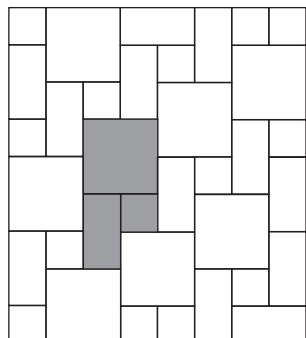

75 × 75 cm: 57 %
 37,5 × 75 cm: 29 %
 37,5 × 37,5 cm: 14 %

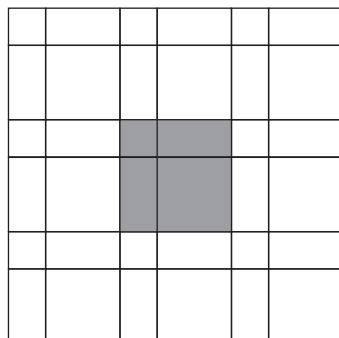

75 × 75 cm: 45 %
 37,5 × 75 cm: 45 %
 37,5 × 37,5 cm: 10 %

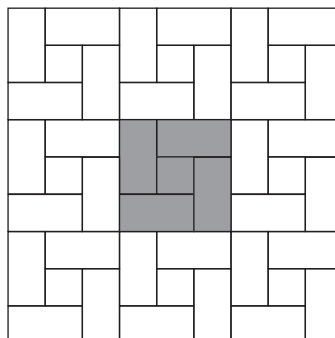

75 × 75 cm: -
 37,5 × 75 cm: 88 %
 37,5 × 37,5 cm: 12 %

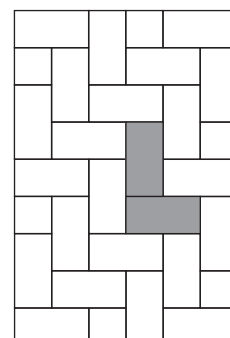

75 × 75 cm: -
 37,5 × 75 cm: 100 %
 37,5 × 37,5 cm: -

BEISPIELE FÜR FLÄCHENVERLEGUNGEN UND BERECHNUNGEN

EXAMPLES FOR LAYINGS AND CALCULATIONS

EXEMPLES POUR SURFACES POSE ET CALCUL

BELFORT

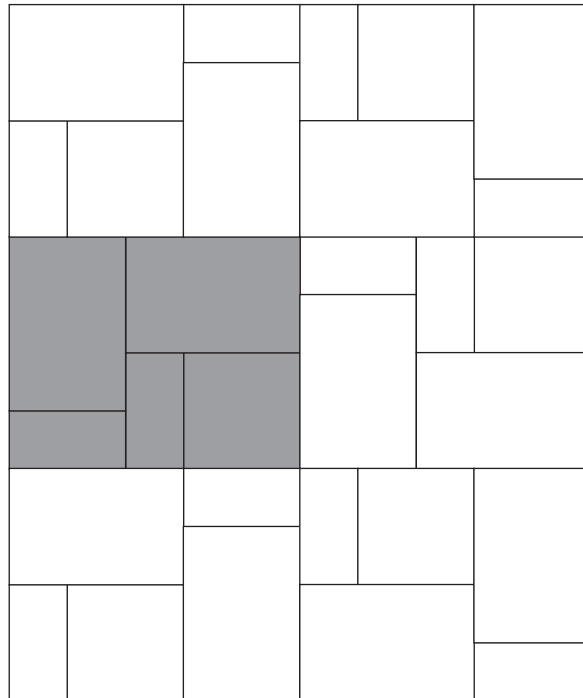

60 × 90 cm: 60 %
 60 × 60 cm: 20 %
 30 × 60 cm: 20 %

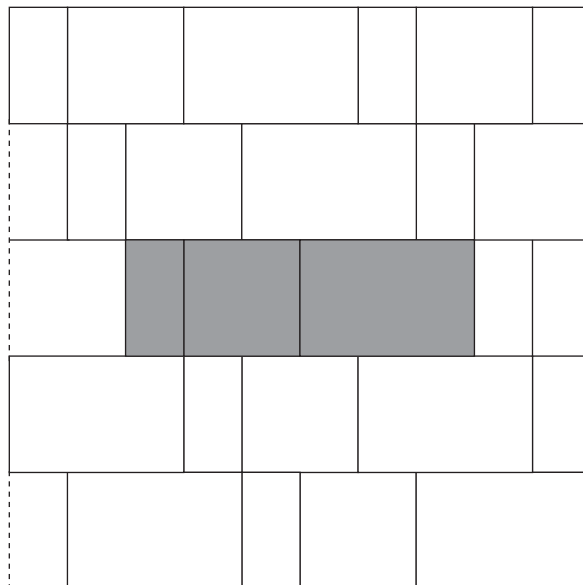

60 × 90 cm: 50 %
 60 × 60 cm: 32 %
 30 × 60 cm: 18 %

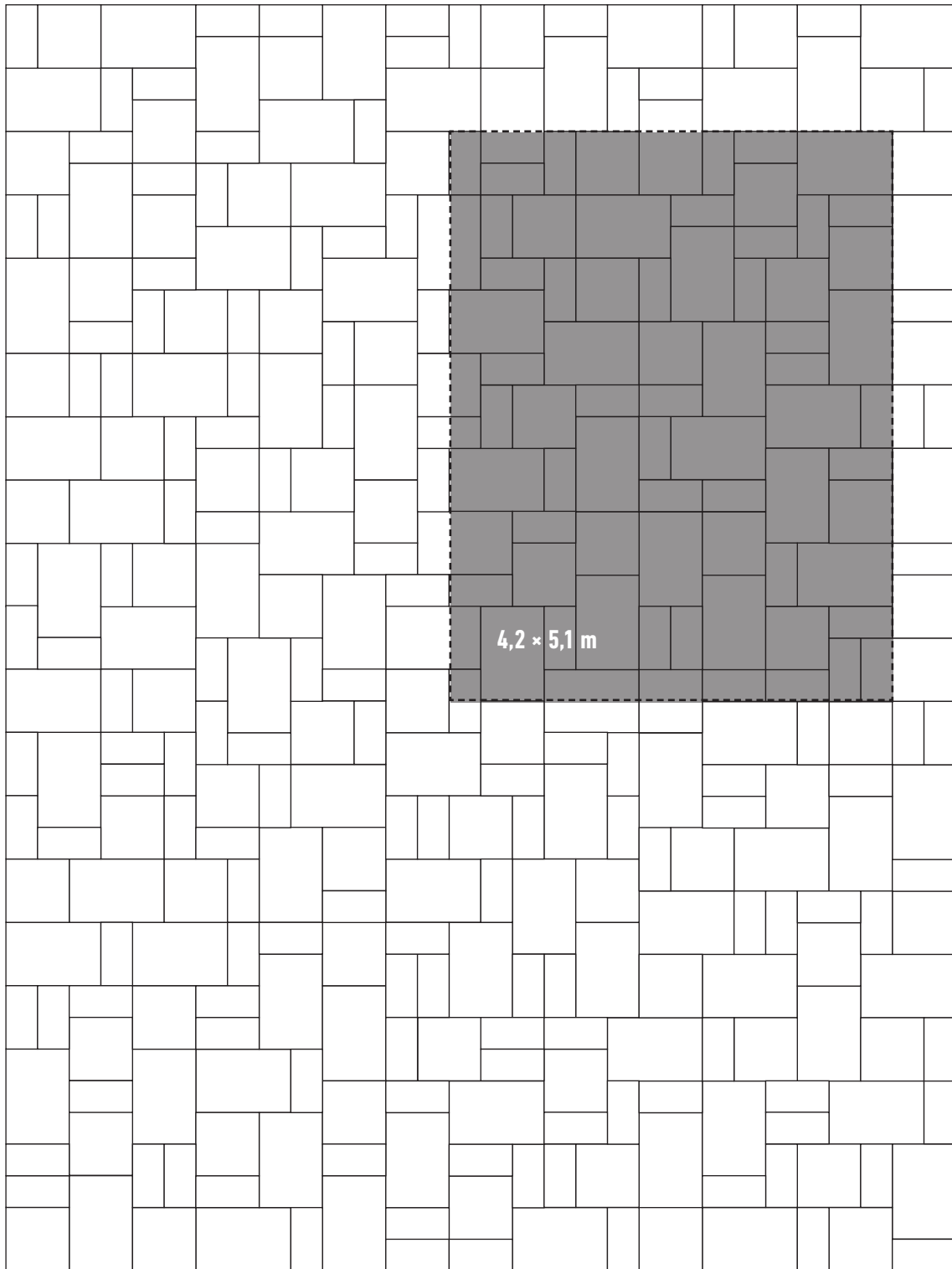

GRUNDFLÄCHE · FLOOR AREA · SUPERFICIE: **9 × 12 m**

MAßSTAB · COPY SCALE · MAQUETTE À L'ÉCHELLE: **1 : 60 cm**



DOWNLOAD

DIN A3 KOPIERVORLAGE · DIN A3 TEMPLATE · DIN A3 MODÈLE DE COPIE

TECHNISCHE INFORMATIONEN BODENFLIESEN

KALIBRIERUNG UND REKTIFIZIERUNG

Rektifizierte Fliesen werden sorgfältig auf Maß nachgearbeitet. Aufgrund ihrer Kalibrierung sind alle Längs- und Breitseiten auf eine einheitliche Größe geschnitten. Nach der Rektifizierung werden alle Fliesen erneut vermessen. Produkte, die dann eine Krümmung oder eine Maßabweichung aufweisen, werden aussortiert. Dieses Veredelungsverfahren bietet zwei Vorteile: Durch das exakte Format können rektifizierte Fliesen mit einer kaum sichtbaren Fuge verlegt werden, und alle Fliesen werden mit einem Kaliber ausgeliefert.

QUALITÄT DER OBERFLÄCHE

1. Sorte: Feinsteinzeugfliesen von der PANARIAgroup Deutschland GmbH entsprechen den Anforderungen der EN 14411 und sind im Innen- und Außenbereich sowie für wechselnde Witterungsbedingungen geeignet. Unter Berücksichtigung der in diesem Katalog angegebenen Empfehlungen für den Anwendungsbereich, garantiert die PANARIAgroup Deutschland GmbH für die Beständigkeit gegen Abrieb und Tiefenverschleiß. Fliesen mit der Kennzeichnung 1. Sorte sind frei von Glasur- oder Scherbenrissen und von sichtbaren Fehlern, die das Aussehen einer größeren gefliesten Fläche beeinträchtigen.

2. Sorte: Fliesen, die den Anforderungen zur Klassifizierung 1. Sorte nicht entsprechen, werden als 2. Sorte deklariert und entsprechen damit nicht den Inhalten der EN 14411.

WASSERAUFNAHME/BESTÄNDIGKEIT GEGEN FROST

Sollen Fliesen in den Außenbereich verlegt werden, müssen sie frostsicher sein. Voraussetzung dafür ist eine geringe Wasseraufnahme. Die Frostbeständigkeit wird nach EN 10545-12 in einem festgelegten Frost-Tau-Zyklus getestet. Nach der Prüfnorm EN 10545-3 wird die Wasseraufnahme im Detail geregelt. Hierbei wird das Gewicht im Verhältnis der trockenen Probe zu aufgenommenem Wasser in Prozent dargestellt. Alle in diesem Katalog enthaltenen PANARIAgroup Deutschland GmbH Artikel sind nach dieser Prüfung aufgrund minimaler Wasseraufnahme als frostbeständig eingruppiert.

RUTSCHHEMMUNG/RUTSCHHEMMUNG IM BARFUSSBEREICH

Die Oberflächeneigenschaften keramischer Bodenfliesen beeinflussen spürbar die Sicherheit von Bewegungen. Die Rutschfestigkeit wird durch eine Reihe von Normen und festgelegten Methoden bewertet:

DIN 51097: Ermittlung der Rutschfestigkeit für nasse Oberflächen im Barfußbereich.

DIN 51130: Ermittlung der Rutschfestigkeit für Arbeitsräume und Arbeitsflächen mit erhöhter Rutschgefahr.

Nach DIN 51130 werden die Bodenfliesen in die mit R9 bis R13 gekennzeichneten Gruppen eingestuft.

R9: Gruppe Rutschwinkel 6 – 10°

R10: Gruppe Rutschwinkel 10 – 19°: Keramische Bodenfliesen
z. B. in Lagern, kleinen Küchen

R11: Gruppe Rutschwinkel 19 – 27°: Keramische Bodenfliesen
z. B. in Küchen, Sanatorien, Waschanlagen, Waschküchen, Schleifwerkstätten

R12: Gruppe Rutschwinkel 27 – 35°: Keramische Bodenfliesen

z. B. in Fleischzubereitungsräumen, Großküchen, Molkereien

R13: Gruppe Rutschwinkel > 35°: Keramische Bodenfliesen

z. B. für Fußböden in Schlachthäusern, Ölraffinerien, Gerbereien

In manchen Bereichen sind die Anforderungen an die Rutschfestigkeit besonders hoch. Bewertet wird die Fähigkeit einer Oberfläche, eine bestimmte Flüssigkeitsmenge abzuleiten, zu verdrängen. Diese Qualität wird nach der Norm 51130 ermittelt: Entscheidend ist das Volumen der Vertiefungen in der Oberfläche und der so genannte Drainageraum, ausgedrückt mit dem Buchstaben „V“ und einer entsprechenden numerischen Angabe (z.B. V 4).

Nach DIN 51097 werden die Bodenfliesen in die mit den Buchstaben A, B, C gekennzeichneten Gruppen eingestuft.

A-Gruppe Rutschwinkel 12°: Barfußgänge (weitgehend trocken); Einzel- und Sammelumkleideräume; Beckenböden in Nichtschwimmerbereichen, wenn im gesamten Bereich die Wassertiefe mehr als 80 cm beträgt; Sauna- und Ruhebereiche (weitgehend trocken)

B-Gruppe Rutschwinkel 18°: Barfußgänge, soweit sie nicht A zugeordnet sind; Duschräume; Bereich von Desinfektionssprühanlagen; Beckenumgänge; Beckenböden im Nichtschwimmerbereich, wenn in Teilbereichen die Wassertiefe weniger als 80 cm beträgt; Beckenböden in Nichtschwimmerbereich von Wellenbecken; Hubböden; Planschbecken; ins Wasser führende Leitern; ins Wasser führende, maximal 1 m breite Treppen mit beidseitigen Handläufen; Leitern und Treppen außerhalb des Beckenbereiches; Sauna- und Ruhebereiche, soweit sie nicht A zugeordnet sind

C-Gruppe Rutschwinkel 24°: Ins Wasser führende Treppen, soweit sie nicht B zugeordnet sind; Durchschreitebecken; geneigte Beckenrandausbildung

ABRIEB

Der Abrieb wird bei glasierten Fliesen in PEI 1 – 5 angegeben. Nach der Prüfnorm EN 10545-7 wird die Veränderung der Oberfläche im PEI Nasstest ermittelt. Mit Aluoxiddörnern, Stahlkugeln und Wasser, die in exzentrisch kreisende Bewegungen versetzt werden, kann ein künstlicher Abrieb erzeugt werden. Die Anzahl der Umdrehungen und der sichtbare Verschleiß der Oberfläche dienen als Maßstab für die Eingruppierung in folgende Beanspruchungsgruppen:

Beanspruchungsgruppe I: Glasierte keramische Bodenbeläge, die bei niedriger Begehungsfrequenz, ohne Vorhandensein von insbesondere kratzender Verschmutzung, mit weich besohlttem Schuhwerk begangen werden. Einsatz im Badezimmer, Schlafräume in Wohnungen ohne direkten Zugang von außen.

Beanspruchungsgruppe II: Glasierte keramische Bodenbeläge, die bei niedriger Begehungsfrequenz unter geringer kratzender Verschmutzung mit normalem Schuhwerk belastet werden. Einsatz im Wohnbereich außer Küchen, Dielen und anderen häufig begangenen Räumen.

Beanspruchungsgruppe III: Glasierte keramische Bodenbeläge, die bei mittlerer Begehungsfrequenz, unter geringer kratzender Verschmutzung mit normalem Schuhwerk belastet werden. Einsatz im gesamten Wohnbereich, Balkone, Loggien, Hotelbäder.

Beanspruchungsgruppe IV: Glasierte keramische Bodenbeläge, die bei stärkerer Begehungsfrequenz mit normalem Schuhwerk in Bezug auf die Verschmutzungs- und Belastungshäufigkeit intensiver beansprucht werden. Einsatz in Eingängen, Verkaufs- und Wirtschaftsräumen, Büros.

Beanspruchungsgruppe V: Glasierte keramische Bodenbeläge, die bei hoher Begehungsfrequenz einer hohen Verschleißbeanspruchung ausgesetzt sind. Einsatz in Läden, Restaurationsbetrieben, Theken- und Schalterbereiche, Garagen.

BESTÄNDIGKEIT GEGEN TIEFENVERSCHLEISS

Bei unglasiertem Feinsteinzeug wird der Tiefenverschleiß getestet. Bei der Prüfung wird die Menge der abgeriebenen Masse gemessen, die ein schleifendes Prüfgerät unter spezifizierten Bedingungen hervorruft. Die Prüfung der Beständigkeit gegen Tiefenverschleiß wird nach Norm EN ISO 10545-6 durchgeführt.

BRUCHLAST

Mit dem Stichwort Bruchlast wird die Fähigkeit von Bodenfliesen bezeichnet, hohen mechanischen Belastungen ohne Beschädigung zu widerstehen. Fliesen von der PANARIAgroup Deutschland GmbH sind 6-11 mm dick und eignen sich damit nicht nur für Anwendungen wie Wohnräume und Verwaltungstrakte, sondern widerstehen auch höheren Belastungen.

BIEGEFESTIGKEIT GEMÄSS EN ISO 10545-4

Als Dreipunktbelastung in N wird die Bruchkraft F berechnet.

Biegefestigkeit

$$R = \frac{3 \times F \times L}{2 \times b \times h^2}$$

F = Bruchkraft in N

R = Biegefestigkeit

S = Bruchlast

Bruchlast

$$S = \frac{F \times L}{b}$$

b = Breite in mm

h = Dicke in mm

L = Stützweite in mm

CHEMISCHE EIGENSCHAFTEN

Die hohe Widerstandskraft der Fliesen der PANARIAgroup Deutschland GmbH gegenüber Chemikalien, Säuren, Laugen und Fleckenbildnern wird in den vorgeschriebenen Prüfverfahren kontrolliert:

Chemische Beständigkeit gemäß EN ISO 10545-13

Wässrige Prüflösungen

- Haushaltschemikalien:
Ammoniumchloridlösung 100g/l;
- Schwimmbadsalze:
Natriumhypochloridlösung 20g/l

Klassen

- unglasiert: A/B/C*
- glasiert: A/B/C*

Säuren und Laugen

- Geringe Konzentration (L)
 - a) Salzsäurelösung 3%
 - b) Zitronensäurelösung 100g/l
 - c) Kaliumhydroxidlösung 30g/l
- Hohe Konzentration (H)
 - a) Salzsäurelösung 18%
 - b) Milchsäurelösung 5%
 - c) Kaliumhydroxidlösung 100g/l

Klassen

- unglasiert: LA/LB/LC bzw. HA/HB/HC*
- glasiert: LA/LB/LC bzw. HA/HB/HC*
- * Klasse A höchste Beständigkeit nach C abnehmend

Fleckbeständigkeit gemäß EN ISO 10545-14

Fleckenbildner

- Spurenbildende Fleckenbildner; grüne Fleckenbildner in Öl; rote Fleckenbildner in Öl; Fleckenbildner chemisch; Jod, 13g/l in Alkohol; filmbildende Fleckenbildner; Olivenöl

Reinigung

- Reinigungsmittel: Heißes Wasser (+55 °C), schwaches Reinigungsmittel, starkes Reinigungsmittel
- Lösungsmittel: Salzsäurelösung 3%; Kaliumhydroxid 200g/l; Aceton

Klassen: 5/4/3/2/1*

- * Klasse 5 weist die höchste Fleckbeständigkeit auf, nach Klasse 1 abnehmend

Blei- und Cadmiumabgabe

Die glasierten Oberflächen werden einer Essigsäure-Lösung ausgesetzt. Anschließend wird die Menge des abgegebenen Bleis und Cadmiums bestimmt.

REINIGUNG VON BODENFLIESEN

Bei der Reinigung von keramischen Bodenbelägen unterscheidet man in Erst- und Grundreinigung sowie laufende Unterhaltsreinigung:

1. Erst-/Grundreinigung

Die Erst- bzw. Grundreinigung erfolgt nach Abschluss der Verlegearbeiten und gehört zum Arbeitsumfang des Fliesenlegers. Durch diese Reinigung werden Rückstände der Verlegearbeiten (Fugenmaterial, Klebstoff, Baustellenschmutz) entfernt sowie Rückstände auf der Materialoberfläche beseitigt. Häufig sind spätere Reinigungsprobleme auf mangelhafte oder fehlende Grundreinigung zurückzuführen. Wir empfehlen die vom Fliesenleger verwendeten, speziell für diesen Bereich vorgesehenen Reinigungsmittel. Vor der Verarbeitung der Reinigungsmittel müssen unbedingt die Beständigkeit der zu reinigenden Oberfläche geprüft und die Hinweise des Herstellers der Reinigungsmittel beachtet werden.

2. Laufende Unterhaltsreinigung

Flüssigkeiten, die Farbstoffe enthalten, Öle und Fette können bei unglasierten Fliesen Flecken hinterlassen. Um hier vorzubeugen, wird die Verwendung handelsüblicher Versiegelungsmittel empfohlen. Der Fliesenleger sollte den Fliesenbelag nach der Grundreinigung,

aber vor der Inanspruchnahme entsprechend behandeln. Für die Reinigung der Fliesen vom normalen Straßenschmutz wird die Verwendung von Wasser empfohlen. Auf jeden Fall sollte auf den Einsatz filmbildender Reinigungsmittel verzichtet werden.

VERLEGUNG

Für die Verlegung von großformatigen Feinsteinzeugfliesen wird je nach Untergrund und Produkt ein C2 S1 oder C2 S2 Kleber empfohlen.

GLEITREIBMESSUNG

Zuständig: Deutsche Gesetzliche Unfallversicherung, Mittelstraße 51, 10117 Berlin-Mitte, Telefon:+ 49 - 30 - 2 88 76 - 38 00, Fax: - 3808, www.dguv.de, info@dguv.de, www.unfallkassen.de.
Prüfnorm: DIN 51131. Merkblatt: DGUV-Information 208-041 „Bewertung der Rutschgefahr unter Betriebsbedingungen“ (bisherige GUV-I 8687).
Diese Prüfung ist keine Baumusterprüfung und kann somit weder zur Auswahl von Bodenbelägen im Planungsstadium noch zu einer Eingruppierung in eine Bewertungsklasse der Rutschhemmung herangezogen werden. Das Verfahren kann z. B. zur Beurteilung des Erfolgs von Reinigungsmaßnahmen oder bei geplanten Nutzungsänderungen angewendet werden. Für die Auswahl eines Bodenbelags sind ausschließlich DGUV-Regel 108-003 (bisherige BGR 181) bzw. DGUV-Information 207-006 (bisherige GUV-I 8527) anzuwenden!

PRIVATBEREICH

Hinsichtlich der Trittsicherheit unterliegen keramische Bodenbelagsflächen im Privatbereich keinen geregelten Vorgaben. Unabhängig davon, empfiehlt es sich, je nach persönlichem Sicherheitsbedürfnis, trittsichere Fliesen zu wählen.

TRITTSICHERHEIT

Gesetzesgrundlage: Die Arbeitsstättenverordnung als auch die Unfallverhütungsvorschriften verlangen, dass Fußböden eben, rutschhemmend und leicht zu reinigen sein müssen. Detaillierte Anforderungen enthält die „Technische Regel für Arbeitsstätten“ ASR. A 1.5/1,2 „Fußböden“ Herausgeber: Bundesanstalt für Arbeitsschutz und Arbeitsmedizin (Ausschuss für Arbeitsstätten) Bezugsquelle: Download unter www.baua.de

ANTIKKANTE

Die Antikkante zeichnet sich durch einen unregelmäßig angelegten Randbereich über einer rektifizierten Kante aus. Sie ist sozusagen ein Hybrid und vereint die Vorzüge einer natürlichen bzw. rustikal anmutenden gepressten Kante mit denen einer rektifizierten Kante.



EN 14411

Anforderungen an Maße und Oberflächenbeschaffenheit sowie physikalische und chemische Eigenschaften müssen mit der Tabelle übereinstimmen.

Maße und Oberflächenbeschaffenheit	Prüfnorm ISO	Gruppe BIII	Gruppe BIA
		Trockengepresste keramische Fliesen und Platten E > 10%; N ≥ 15 cm	Trockengepresste keramische Fliesen und Platten mit niedriger Wasseraufnahme E ≤ 0,5 %
			Oberfläche S [in cm ²] > 410
Länge und Breite [Abweichung in %]	10545 - 2	± 0,5 % / ± 2,0 mm	± 0,6 % / ± 2,0 mm
Dicke [Abweichung in % von der vom Hersteller festgelegten Dicke]	10545 - 2	± 10 % / ± 0,5 mm	± 5,0 % / ± 0,5 mm
Gradheit der Kanten (Ansichtfläche) [maximale Abweichung in %, bezogen auf das Werkmaß]	10545 - 2	± 0,3 % / ± 1,5 mm	± 0,5 % / ± 1,5 mm
Rechtwinkligkeit [maximale Abweichung in %, bezogen auf das Werkmaß]		± 0,5 % / ± 2,0 mm	± 0,5 % / ± 2,0 mm
Ebenmäßigkeit [maximale Abweichung in %] a) Mittelpunktwölbung Diagonale b) Kantenwölbung c) Windschiefe Diagonale	10545 - 2	a) + 0,5 % / + 2,0 mm - 0,3 % / - 1,5 mm b) + 0,5 % / + 2,0 mm - 0,3 % / - 1,5 mm c) ± 0,5 % / ± 2,0 mm	a) ± 0,5 % / ± 2,0 mm b) ± 0,5 % / ± 2,0 mm c) ± 0,5 % / ± 2,0 mm
Oberflächenbeschaffenheit	10545 - 2	Mindestens 95% der Fliesen und Platten müssen frei von sichtbaren Fehlern sein, die das Aussehen einer größeren Fliesenfläche beeinträchtigen.	Mindestens 95% der Fliesen und Platten müssen frei von sichtbaren Fehlern sein, die das Aussehen einer größeren Fliesenfläche beeinträchtigen.
Physikalische Eigenschaften			
Wasseraufnahme [in Gew.-%]	10545 - 3	im Mittel > 10%. Übersteigt der Wert 20%, ist dies ausgewiesen.	< 0,5% max. Einzelwert 0,6%
Bruchlast [in N] a) Dicke ≥ 7,5 mm b) Dicke < 7,5 mm	10545 - 4	a) min. 600 b) min. 200	a) min. 1.300 b) min. 700
Biegefestigkeit [in N/mm ²] a) Dicke ≥ 7,5 mm b) Dicke < 7,5 mm	10545 - 4	a) min. 12 b) min. Einzelwert 15	a) min. 35 b) min. Einzelwert 32
Widerstand gegen Verschleiß a) von unglasierten Fliesen und Platten: Volumenverlust b) von glasierten Fliesen und Platten zur Herstellung von Bodenbelägen	10545 - 6 10545 - 7	- Die Verschleißklasse und die Anzahl der Schleifzyklen sind anzugeben.	a) max. 175 mm ³ b) Die Verschleißklasse und die Anzahl der Schleifzyklen sind anzugeben.
Linearer Wärmeausdehnungskoeffizient [bei Raumtemperatur bis 100 °C]	10545 - 8	Prüfverfahren vorhanden	Prüfverfahren vorhanden
Temperaturwechselbeständigkeit	10545 - 9	Prüfverfahren vorhanden	Prüfverfahren vorhanden
Widerstand gegen Glasrisse	10545 - 11	gefordert	gefordert
Frostbeständigkeit	10545 - 12	Prüfverfahren vorhanden	gefordert
Reibungskoeffizient (Fliesen und Platten zur Herstellung von Bodenbelägen)	Angabe des Prüfverfahrens	sofern gefordert	sofern gefordert
Feuchtedehnung [in mm/m]	10545 - 10	Prüfverfahren vorhanden	Prüfverfahren vorhanden
Kleine Farbabweichungen	10545 - 16	Prüfverfahren vorhanden	Prüfverfahren vorhanden
Schlagfestigkeit	10545 - 5	Prüfverfahren vorhanden	Prüfverfahren vorhanden
Chemische Eigenschaften			
Fleckbeständigkeit a) glasierte Fliesen und Platten b) unglasierte Fliesen und Platten	10545 - 14	a) min. Klasse 3 b) Prüfverfahren vorhanden	a) min. Klasse 3 b) Prüfverfahren vorhanden
Beständigkeit gegen Chemikalien a) Säuren und Laugen mit niedriger Konzentration b) Säuren und Laugen mit hoher Konzentration	10545 - 13	a) Prüfverfahren vorhanden b) Prüfverfahren vorhanden	a) Die Klasse ist vom Hersteller anzugeben. b) Prüfverfahren vorhanden
Haushaltschemikalien und Badewasserzusätze (Schwimmbecken)	10545 - 13	min. B	min. B
Abgabe von Blei und Cadmium	10545 - 15	Prüfverfahren vorhanden	Prüfverfahren vorhanden

VERKAUFS-, LIEFERUNGS- UND ZAHLUNGSBEDINGUNGEN

Gültig ab 1. Januar 2024 Lieferungen erfolgen ausschließlich zu unseren Verkaufs-, Lieferungs- und Zahlungsbedingungen. Etwa anders lautende Einkaufsbedingungen des Käufers werden durch die Annahme seines Auftrages nicht anerkannt. Durch die Annahme der von uns gelieferten Waren erklärt der Käufer sein Einverständnis mit unseren Bedingungen. Sofern eine der nachstehenden Verkaufs-, Lieferungs- und Zahlungsbedingungen durch anderslautende gesetzliche Regelung oder Rechtsprechung ungültig werden sollte, gilt als vereinbart, dass hierdurch die Rechtsgültigkeit der übrigen Verkaufs-, Lieferungs- und Zahlungsbedingungen in ihrer Gesamtheit nicht berührt werden.

- Angebote** Unsere Angebote sind, soweit sie nicht als „fest“ oder „verbindlich“ bezeichnet sind, freibleibend und verpflichten nicht zur Auftragsannahme. Unsere Angebote beziehen sich auf die zum Zeitpunkt der Angebotsabgabe jeweils gültigen Preislisten, Kataloge und Prospekte.
- Preise** Die Preise richten sich nach der am Tage der Lieferung gültigen Preisliste. Wir behalten uns vor, unterjährige Preisanpassungen bzw. Zuschläge vorzunehmen, sofern sich die Rohstoff-, Energie- oder Frachtkosten am Markt allgemein deutlich erhöhen.
- Sortierung** Unsere keramischen Fliesen werden in folgender Weise sortiert: 1. Sortierung – diese entspricht der DIN EN 14411. An die 1. Sortierung können normale Anforderungen hinsichtlich einwandfreier Scherben, Oberfläche, Sauberkeit und Schönheit der Glasur gestellt werden. Kleine Mängel, geringe Form- und Farbabweichungen der einzelnen Fliesen sind zulässig, soweit sie bei sachgemäßer Verlegung das Gesamtbild nicht beeinträchtigen. 2. Sortierung – Fliesen mit deutlich erkennbaren Fehlern, die nicht als 1. Sorte bezeichnet werden können. Die Erfüllung von Güteanforderungen nach DIN EN 14411 ist nicht Voraussetzung.
- Kennzeichnung** Die Qualität der Fliesen wird wie folgt gekennzeichnet: 1. Sortierung: Verpackung, die den Text „1. Sortierung“ und DIN EN 14411 enthält. Abweichende Qualitäten zur 1. Sortierung werden entsprechend gekennzeichnet. Für die nicht in 1. Sortierung gelieferten Waren übernehmen wir keine Gewährleistung.
- Lieferzeiten** Lieferfristen oder -termine werden erst durch unsere schriftliche Bestätigung verbindlich und beginnen erst mit dem Tage der völligen Klarstellung des betreffenden Auftrages auf Grund Versendung unserer schriftlichen Bestätigung. Wesentliche Lieferverzögerungen infolge Fehlbrandes, Fabrikationsstörungen, Streiks und sonstige Umstände, auf welche wir keinen Einfluss haben, werden dem Kunden mitgeteilt und berechtigen zu einer angemessenen Verlängerung der Lieferzeit. Die Lieferzeit gilt als eingehalten, wenn die Absendung der Ware vor Ablauf der Lieferfrist erfolgt ist.
- Verzug** Haben wir eine Verzögerung oder Unterbrechung der Lieferung zu vertreten, so kann der Käufer eine angemessene Nachfrist setzen und, wenn diese erfolglos verläuft, vom Vertrag zurücktreten. Weitere Ansprüche, insbesondere solche auf Schadenersatz, bestehen, vorbehaltlich der Regelung in Ziff. 12, nicht. Aufträge mit Abruffrist können bei nicht rechtzeitiger Annahme der Ware nach einer einwöchigen Nachfrist von uns für ungültig erklärt werden.
- Verpackung und Verladung** Unsere Angebotspreise verstehen sich einschließlich Ladekosten für den LKW-Versand. Die Verladung unserer Ware erfolgt unter anderem auf EURO-Paletten. Sofern die EURO-Paletten bei der Abholung in einem unserer Werke oder der Lieferungen innerhalb der Bundesrepublik Deutschland gegen eine entsprechende Anzahl intakter Paletten getauscht werden, werden die EURO-Paletten nicht berechnet. Großformatige Fliesen und Slabs liefern wir auf Sonderpaletten (nicht EURO-Paletten). Ein Tausch und/oder die Rückgabe dieser Sonderpaletten ist ausgeschlossen. Bei frachtfreier Rücksendung der EURO-Paletten in einwandfreiem Zustand schreiben wir diese unseren Kunden anteilig gut. Die Preise, sowie der damit verbundene Gutschriftbetrag für die EURO-Paletten, richten sich nach der am Tag der Lieferung gültigen Frachtpreistabelle.
- Versand in Deutschland (nur Festland)** Verkäufe erfolgen ab Werk, der Versand auf Rechnung und Gefahr des Käufers. Abholung durch den Käufer nur nach ausdrücklicher Vereinbarung. Ist eine Transportversicherung erwünscht, trägt der Käufer die Versicherungskosten. Teillieferungen sind stets zulässig, dabei bemühen wir uns, so frachtgünstig wie möglich zu versenden. Wir haften nur für solche Schäden, die ausschließlich auf eine unsachgemäße Verpackung zurückzuführen sind. Transportschäden sind stets sofort beim Transportunternehmer zur Prüfung anzumelden, wobei die für solche Fälle vorgesehene Verhandlungsniederschrift zu fordern ist. Der Versand außerhalb Deutschland (Festland) wird individuell geregelt und vereinbart.
- Zahlungsbedingungen** Die Rechnung wird am Tage des Versandes ausgestellt und ist zahlbar spätestens 30 Tage nach Rechnungsdatum ohne Abzug. Bei Zahlung innerhalb von 8 Tagen ab Rechnungsdatum gewähren wir 2 % Skonto vom skontierfähigen ausgewiesenen Betrag. Bei Überschreitung des Zieles sind wir berechtigt, Verzugszinsen zu berechnen. Die Gewährung des Skontos hat zur Voraussetzung, dass alle vorher fälligen Forderungen ausgeglichen sind. Bei Zahlungen mit Akzepten oder Kundenwechseln ist Voraussetzung, dass die Zahlung innerhalb von 8 Tagen nach Rechnungsdatum erfolgt. Die Laufzeit darf nicht über 3 Monate betragen, die Annahme müssen wir uns von Fall zu Fall (Diskontmöglichkeit) vorbehalten, und die gesamten Diskontspesen gehen zu Lasten des Kunden. Zahlungen durch Scheck gelten erst mit deren Einlösung als erfüllt. Der Lieferant hat das Recht, seine Forderungen gegen den Käufer (Abnehmer) an einen Dritten abzutreten. Nur schriftlich von uns anerkannte oder rechtskräftige Gegenansprüche berechtigen den Käufer zur Aufrechnung oder Zurückbehaltung fälliger Zahlungen. Mängelrügen entbinden den Auftraggeber nicht von der fristgerechten Begleichung der Rechnung, soweit wir dem Auftraggeber eine Bankbürgschaft über den eingeklagten Betrag zur Verfügung stellen, die bis 14 Tage nach Rechtskraft des Urteils über die Mängelrüge gültig ist und zur Sicherung des Gegenanspruchs aus der Mängelrüge dient. Soweit der Käufer im Rechtsstreit unterliegt, trägt er die Kosten der Bankbürgschaft. Wenn vorstehende Zahlungsbedingungen nicht eingehalten werden oder wenn sich die Zahlungsweise eines Abnehmers uns oder anderen Gläubigern gegenüber verschlechtert (z. B. Wechselproteste oder Klagen und dergleichen), werden unsere Forderungen sofort fällig, auch wenn wir dagegen Wechsel oder Akzente

mit späterer Fälligkeit angenommen haben. Außerdem behalten wir uns in diesem Falle Vorauszahlungen auch nach Abschluss des Liefervertrages vor.

10. Eigentumsvorbehalt

- Wir behalten uns das Eigentum an sämtlichen von uns gelieferten Waren vor, bis der Käufer sämtliche Forderungen aus der Geschäftsverbindung, insbesondere aus einem etwaigen Kontokorrent-Saldo bezahlt hat. Pfändungen seitens anderer Gläubiger sind uns unverzüglich mitzuteilen.
- Bei Zahlungsverzug, bei Eintritt einer wesentlichen Verschlechterung der Vermögensverhältnisse des Käufers, bei Eröffnung des gerichtlichen oder außergerichtlichen Vergleichsverfahrens oder des Konkurses über das Vermögen des Käufers können wir, ohne vom Vertrag zurückzutreten, Rückgabe der Sache verlangen, wobei die Kosten des Rücktransportes vom Käufer zu tragen sind. Das gleiche gilt, wenn nach der Lieferung bei uns begründete Zweifel über Zahlungsfähigkeit oder Zahlungsbereitschaft entstehen.
- Der Käufer darf die unter Eigentumsvorbehalt stehende Ware, solange er nicht in Zahlungsverzug ist, nur im ordnungsgemäßen Geschäftsbetrieb weiter veräußern bzw. weiterverarbeiten; er darf sie weder an Dritte verpfänden noch als Sicherheit übereignen. Bei Verarbeitung/Bearbeitung, Vermischung/Vermengung oder Veräußerung der von uns gelieferten Ware entstehende Forderungen tritt der Käufer in Höhe desjenigen Betrages, mit dem unsere hierbei verwandte Vorbehaltsware von dem Käufer in Rechnung gestellt war oder in Sammelrechnung kalkuliert ist, mit Rang vor dem Rest schon jetzt an uns ab. Der Käufer ist verpflichtet, auf unser Verlangen die Namen der Drittschuldner sowie die oben bezeichneten Beträge anzugeben; wir wählen auf Anforderung des Käufers durch schriftliche Erklärung ihm gegenüber aus den uns so abgetretenen Forderungen die zur Sicherung unseres Saldos erforderlichen aus; mit dem Eingang dieser Erklärung bei dem Käufer werden die darüber hinaus bestehenden Abtretungen rückwirkend aufgehoben. Bestehen bezüglich der Forderung des Käufers gegen den Drittschuldner neben unseren Vorausabtretungen auch noch solche an andere Lieferanten, die sich gegenseitig beeinträchtigen, so soll die Forderung des Käufers gegen den Drittschuldner allen Vorausabtretungsgläubigern im Verhältnis ihrer Forderung gegen den Drittschuldner zustehen.
- Der Käufer hat uns abgetretene, von ihm aber eingezogene Forderungen zur Abdeckung seiner fälligen Verpflichtungen sofort zu überweisen, bis dahin aber in seinen Büchern diese Gegenstände als Fremdbestände für uns zu kennzeichnen und treuhänderisch zu verwahren.
- Wir verpflichten uns, die uns nach den vorstehenden Bestimmungen zustehenden Sicherungen insoweit – nach unserer Wahl – freizugeben, als ihr realisierbarer Wert die zu sichernden Forderungen um 20 % übersteigt. Mit der vollständigen Bezahlung aller unserer Forderungen aus der Geschäftsverbindung gehen ohne weiteres das Eigentum an der von uns gelieferten Ware und die an uns abgetretenen Forderungen auf den Käufer über.

11. Beschaffenheit und Mängelansprüche

- Unsere Fliesen entsprechen den Merkmalen der DIN EN 14411. Infolge der Besonderheit der keramischen Herstellung bedingte Abweichungen in den Maßen, Gewichten, Farbönen und der Oberflächenbeschaffenheit der Fliesen, die sich in branchenüblichem Umfang zeigen, stellen keinen Mangel dar. Säurehaltige und/oder ätzende Reinigungsmittel können bei unsachgemäßer Verwendung Schäden verursachen. Fehlende Waren sind unmittelbar nach Empfang der Sendung zu reklamieren. Das gleiche gilt, wenn andere als die bestellten Waren geliefert werden. Für die nicht in 1. Sortierung gelieferten Waren übernehmen wir keine Gewährleistung.
- Offensichtliche Mängel sind unverzüglich, in jedem Falle vor Verarbeitung der Fliesen schriftlich zu rügen. Verdeckte Mängel sind unverzüglich nach ihrer Feststellung zu rügen. Beanstandungen, die nach Ablauf der Rügefrist vorgetragen werden, können von uns abgelehnt werden.
- Ist von uns gelieferte Ware mangelhaft (gemäß a), sind wir unter Ausschluss weiterer Gewährleistungsansprüche des Käufers verpflichtet, Ersatz zu liefern. Sollten wir nicht innerhalb einer uns vom Kunden schriftlich aufgegebenen angemessenen Nachfrist Ersatz geleistet haben, so kann der Käufer unter Ausschluss aller anderen Ansprüche vom Vertrag zurücktreten oder eine Preisminderung verlangen.
- Wird ein beanstandeter Fliesenbelag ohne unsere vorherige schriftliche Einwilligung entfernt, lehnen wir jegliche Gewährleistung ab.
- Fleesenereste werden nicht zurückgenommen. Wir sind nicht verpflichtet, ohne unsere Genehmigung zurückgesandte Ware anzunehmen. Wir sind berechtigt, sie auf Kosten und Gefahr des Absenders zurückzusenden oder zu lagern.
- Es gelten die gesetzlichen Verjährungsfristen für Mängelansprüche.

12. Sonstige Haftung Jede über vorstehenden Bestimmungen hinausgehende Haftung sowie alle sonstigen und weitergehenden Ansprüche, gleich aus welchem Rechtsgrund (z.B. unerlaubter Handlung, Verzug, Verschulden beim Vertragsschluss, Gefährdungshaftung usw.), insbesondere auf Schadenersatz, sind ausgeschlossen. Für über leichte Fahrlässigkeit hinausgehendes Verschulden unserer leitenden Angestellten und gesetzlichen Vertreter sowie für das Fehlen ausdrücklich zugesicherter Eigenschaften wird jedoch bis zu einer Höhe von 25 % des Auftragswertes gehaftet. Für Ansprüche nach Produkthaftungsgesetz und Rückgriffsansprüche aus einem Verbrauchsgüterkauf haften wir im Rahmen der gesetzlichen Bestimmungen.

13. Auslandspreise Für Angebote und Verkäufe ins Ausland bedarf es in jedem Fall der vorherigen besonderen Vereinbarung mit uns.

14. Gerichtsstand Für die Geschäftsbeziehung zwischen Lieferant und Käufer (Abnehmer) gilt deutsches Recht. Der Käufer (Abnehmer) hat alle Gebühren, Kosten und Auslagen zu tragen, die im Zusammenhang mit jeder gegen ihn rechtlich erfolgreichen Rechtsverfolgung außerhalb Deutschlands anfallen. Der Gerichtsstand ist Hamburg.

15. Datenschutz Wir weisen darauf hin, dass personenbezogene Daten unserer Vertragspartner bei uns im Sinne des Bundesdatenschutzgesetzes gespeichert, übermittelt und – soweit erforderlich – geändert werden.

TECHNICAL INFORMATION FLOOR TILES

CALIBRATION AND RECTIFICATION

Rectified tiles are carefully reworked to size. Because they are calibrated, all long and short sides are cut to a uniform size. After rectification, all of the tiles are remeasured. Products that then show curvature or a deviation in size are sorted out. This finishing process offers two advantages: thanks to the exact form, rectified tiles can be installed with nearly invisible joints and all tiles are delivered with the same size.

SURFACE QUALITY

1st Quality: Porcelain stoneware tiles by PANARIAgroup Deutschland GmbH meet the requirements of EN 14411 and are suitable for use indoors and outdoors as well as under changing weather conditions. Taking into account the recommendations stated in this catalogue with regard to the area of application, PANARIAgroup Deutschland GmbH guarantees resistance to abrasion and scratching. Tiles that are marked "1st Quality" are free from crazing or cracking and visible flaws that detract from the appearance of a large tiled surface.

Seconds: Tiles that fail to meet the requirements for classification as 1st Quality are declared to be seconds and thus do not comply with the provisions of EN 14411.

WATER ABSORPTION/FROST-RESISTANCE

Tiles intended for installation outdoors must be frost proof. The prerequisite for this is low water absorption. Frost-resistance is tested in accordance with EN 10545-12 in a specified freeze/thaw cycle. Water absorption in detail is governed by the inspection and testing standard EN 10545-3. The process stipulates the relationship between the weight of the dry sample and the weight including the water absorbed as a percentage. All of the PANARIAgroup Deutschland GmbH articles contained in this catalogue have been classified as frost proof after this test due to minimal water absorption.

SLIP-RESISTANCE/ANTI-SKID PROTECTION IN BAREFOOT AREAS

The surface properties of ceramic floor tiles noticeably influence safety of movement. Slip-resistance is evaluated according to a series of standards and defined methods:

DIN 51097: Determination of slip-resistance for wet surfaces in barefoot areas.

DIN 51130: Determination of slip-resistance for work rooms and working areas with increased risk of skidding.

In accordance with DIN 51130, floor tiles are categorised in groups designated R9 through R13.

- R9:** Group slip angle 6 – 10°
- R10:** Group slip angle 10 – 19°: Ceramic floor tiles, e. g., in storerooms, small kitchens
- R11:** Group slip angle 19 – 27°: Ceramic floor tiles, e. g., in kitchens, sanatoriums, car washes, laundries, grinding shops
- R12:** Group slip angle 27 – 35°: Ceramic floor tiles, e. g., in meat processing areas, industrial kitchens, dairies
- R13:** Group slip angle > 35°: Ceramic floor tiles, e. g., for floors in slaughterhouses, oil refineries, tanneries

In many areas, demands with regard to slip-resistance are especially high. What is evaluated is the ability of a relieftype surface to divert or displace a given quantity of fluid. This property is determined in accordance with Standard 51130. What is decisive is the volume of indentations in the surface and the so-called drainage space, expressed by the letter "V" and a corresponding number (e.g., V 4).

In accordance with DIN 51097, floor tiles are categorised in groups designated by the letters A, B, and C.

A Group slip angle 12°: Barefoot walking (largely dry): Individual and group changing rooms; pool floors in non-swimmer areas, if the water depth in the entire area exceeds 80 cm; sauna and rest areas (largely dry)

B Group slip angle 18°: Barefoot walking, unless allocated to "A"; shower areas; disinfection spray system areas; walking areas around pools; pool floors in the non-swimmer area if the water depth in parts of the area is less than 80 cm; pool floors in the non-swimmers area of swimming pools with wave machines; adjustable height pool floors; wading pools; ladders leading into the water; stairs leading into the water with a max. width of 1 m and railings on both sides; ladders and stairs outside of the pool area; sauna and rest areas, provided they are not allocated to "A"

C Group slip angle 24°: Steps leading into the water, unless they are allocated to "B"; walk-through pools; slanted pool walls

ABRASION

For glazed tiles, resistance to surface abrasion is stated in terms of PEI 1 – 5. In accordance with test standard EN 10545-7, resistance to surface abrasion is determined in a PEI wet test. Artificial abrasion can be created using aluminium oxide particles, steel shot and water set in an eccentric circular motion. The number of rotations and the visible abrasion of the surface serve as a measure for classification in the following stress groups:

Stress group I: Glazed ceramic floor coverings that can be walked on with soft-soled shoes in low-traffic areas without especially abrasive dirt. Use in bathrooms, bedrooms in dwellings without direct access from outside.

Stress group II: Glazed ceramic floor coverings which can be walked on with normal shoes in low-traffic areas with low levels of abrasive dirt. Use in domestic areas except for kitchens, hallways, and other high-traffic areas.

Stress group III: Glazed ceramic floor coverings which can be walked on with normal shoes in medium-traffic areas with low levels of abrasive dirt. Use throughout residential areas, balconies, loggias, hotel bathrooms.

Stress group IV: Glazed ceramic floor coverings that can be stressed more intensively in terms of frequency of soiling and use with normal shoes in high-traffic areas. Use in entryways, salesrooms and working areas, offices.

Stress group V: Glazed ceramic floor coverings that are exposed to a high level of wear in high-traffic areas. Use in restaurants, bar and counter areas, garages.

SCRATCH-RESISTANCE

Scratch-resistance is tested with unglazed stoneware. In this test, the quantity of mass abraded by a grinding testing device is measured under specific conditions. The scratch-resistance test is carried out in accordance with standard EN ISO 10545-6.

BREAKING LOAD

The term “breaking load” denotes the ability of floor tiles to withstand high mechanical loads without damage. PANARIAGroup Deutschland GmbH tiles are 6-11 mm thick and are thus suitable not only for applications such as residential and administrative areas, but are capable of withstanding even heavier loads.

BENDING STRENGTH IN ACCORDANCE WITH EN ISO 10545-4

The breaking load F is computed as a bending resistance between two supports in N.

Bending strength

$$R = \frac{3 \times F \times L}{2 \times b \times h^2}$$

F = Breaking load in N

R = Bending strength

S = Breaking load

Breaking load

$$S = \frac{F \times L}{b}$$

b = Width in mm

h = Thickness in mm

L = Width between supports in mm

CHEMICAL PROPERTIES

The high resistance of PANARIAGroup Deutschland GmbH tiles to chemicals, acids, alkalines and stains is tested using the prescribed test procedure:

Resistance to chemicals in accordance with EN ISO 10545-13

Watery test solutions

- Household chemicals:
 - Ammonium chloride solution 100g/l;
- Swimming pool salts:
 - Sodium hypochloride solution 20g/l

Classes

- unglazed: A/B/C*
- glazed: A/B/C*

Acids and alkalines

- Low concentration (L)
 - a) Hydrochloric acid solution 3%
 - b) Citric acid solution 100g/l
 - c) Potassium hydroxide solution 30g/l
- High concentration (H)
 - a) Hydrochloric acid solution 18%
 - b) Lactic acid solution 5%
 - c) Potassium hydroxide solution 100g/l

Classes

- unglazed: LA/LB/LC or HA/HB/HC*
- glazed: LA/LB/LC or HA/HB/HC*
- * Class A max. resistance declining to C

Stain-resistance in accordance with EN ISO 10545-14

Staining agents

- Trace-forming staining agents; green staining agents in oil; red staining agents in oil; chemical staining agents; iodine 13g/l alcohol; film-forming staining agents; olive oil

Cleaning

- Cleaning agent: hot water (+55 °C), gentle cleaning agent, strong cleaning agent
- Solvent: hydrochloric acid solution 3%; potassium hydroxide 200g/l; acetone

Classes: 5/4/3/2/1*

* Class 5 specifies max. resistance to staining, declining to Class 1

Lead and cadmium leaching

Glazed surfaces are exposed to an acetic acid solution. The volume of lead and cadmium discharged is then measured.

CLEANING FLOOR TILES

When cleaning ceramic floor tiles, we make a distinction between the initial clean or a thorough clean and everyday maintenance cleaning.

1. Initial / Thorough clean

An initial / thorough clean is carried out once the tiles have been fully laid and is the responsibility of the tiler. This cleaning process removes residues from the laying work (jointing material, adhesive, site dirt) and residues on the surface of the materials. Subsequent cleaning problems can often be attributed to inadequate or faulty initial cleaning. We recommend the detergent used by the tiler and designed specially for this application. Before using the detergent, it is important to check the composition of the surface to be cleaned and comply with the instructions provided by the detergent manufacturer.

2. Ongoing maintenance cleaning

Liquids which contain dye, oils and fat can stain unglazed tiles. In order to prevent this, we recommend the use of conventional sealants. The tiler should treat the tiled surface accordingly after initial cleaning but before first use. It is recommended that water is used to clean the tiles from normal street grime. Detergents which form a film should be avoided.

LAYING

For laying large-format porcelain gres tiles, a C2 S1 or C2 S2 adhesive is recommended depending on the substrate and the product.

MEASUREMENT OF SLIDING FRICTION

Competent authority: Deutsche Gesetzliche Unfallversicherung, Mittelstrasse 51, 10117 Berlin-Mitte, Telephone: + 49 - 30 - 2 88 76-38 00, Fax: - 3808, www.dguv.de, info@dguv.de, www.unfallkassen.de.
Test standard: DIN 51131.

Information leaflet: DGUV Information 208-041 "Bewertung der Rutschgefahr unter Betriebsbedingungen" [Assessment of slipping hazard in operating conditions] (previously GUV-I 8687). This test is not a type approval test and can therefore not be used to select floor coverings in the planning stage or to rate a floor covering in a slip-resistance assessment class. The procedure may, for example, be used to assess the success of cleaning measures or for planned changes in use. Only DGUV Regulation 108-003 (previously BGR 181) and DGUV Information 207-006 (previously GUV-I 8527) respectively are to be used for selecting a floor covering!

PRIVATE USE

Ceramic floor coverings in private property are not subject to any statutory requirements with regard to slip-resistance. Nonetheless, it is advisable to select slip-resistant tiles according to personal safety needs.

SLIP-RESISTANCE

Legal Basis: The German Workplace Ordinance and accident prevention regulations require floors to be even, slip-resistant and easy to clean. Detailed requirements can be found in "Technical regulations for workplaces" ASR. A 1.5/1,2 "Floors". Publisher: German Federal Institute for Occupational Safety and Health (Committee on Workplaces).
Source: Download at www.baua.de

ANTIQUE EDGE

The antique edge is characterised by an irregular border area over a rectified edge. It is a hybrid combining the advantages of a pressed edge that appears natural or rustic with those of a rectified one.



Requirements relating to dimensions and surface quality as well as physical and chemical properties must be in accordance with the table below.

Dimensions and surface quality	Teststandard ISO	Group BIII	Group BIA
		Dry-pressed ceramic tiles and slabs E > 10 %; N ≥ 15 cm	Dry-pressed ceramic tiles and slabs with low water absorption E ≤ 0.5%
			Surface S [in cm ²] > 410
Length and width [variation in %]	10545 - 2	± 0,5 % / ± 0,2 mm	± 0,6 % / ± 2,0 mm
Thickness [variation in % from thickness specified by manufacturer]	10545 - 2	± 10 % / ± 0,5 mm	± 5,0 % / ± 0,5 mm
Straightness of edges (plain of projection) [maximum variation in % related to work size]	10545 - 2	± 0,3 % / ± 1,5 mm	± 0,5 % / ± 1,5 mm
Rectangularity [maximum variation in % related to work size]	10545 - 2	± 0,5 % / ± 2,0 mm	± 0,5 % / ± 2,0 mm
Flatness [maximum variation in %] a) Diagonal centre curvature b) Edge curvature c) Skew diagonal	10545 - 2	a) + 0,5 % / + 2,0 mm - 0,3 % / - 1,5 mm b) + 0,5 % / + 2,0 mm - 0,3 % / - 1,5 mm c) ± 0,5 % / ± 2,0 mm	a) ± 0,5 % / ± 2,0 mm b) ± 0,5 % / ± 2,0 mm c) ± 0,5 % / ± 2,0 mm
Surface quality	10545 - 2	At least 95% of the tiles and slabs must be free of visible faults that might affect the appearance of a larger area of tiles.	At least 95% of the tiles and slabs must be free of visible faults that might affect the appearance of a larger area of tiles.
Physical properties			
Water absorption [in % of weight]	10545 - 3	Average > 10%. A value exceeding 20% has to be reported.	< 0.5% max. isolated value 0.6%
Breaking load [in N] a) Thickness ≥ 7.5 mm b) Thickness < 7.5 mm	10545 - 4	a) min. 600 b) min. 200	a) min. 1.300 b) min. 700
Flexural strength [in N/mm ²] a) Thickness ≥ 7.5 mm b) Thickness < 7.5 mm	10545 - 4	a) min. 12 b) min. isolated value 15	a) min. 35 b) min. isolated value 32
Wear resistance a) of unglazed tiles and slabs: volume loss b) of glazed tiles and slabs for the production of flooring materials	10545 - 6 10545 - 7	- Wear classification and number of grinding cycles to be indicated.	a) max. 175 mm ³ b) Wear classification and number of grinding cycles to be indicated.
Linear thermal expansion coefficient [at ambient temperature up to 100 °C]	10545 - 8	test method available	test method available
Resistance to thermal shocks	10545 - 9	test method available	test method available
Resistance to crazing	10545 - 11	required	required
Frost-resistance	10545 - 12	test method available	required
Coefficient of friction (tiles and slabs for the production of flooring materials)	Indicate test method	if required	if required
Expansion in moisture [in mm/m]	10545 - 10	test method available	test method available
Minor colour variations	10545 - 16	test method available	test method available
Impact strength	10545 - 5	test method available	test method available
Chemical properties			
Stain resistance a) glazed tiles and slabs b) unglazed tiles and slabs	10545 - 14	a) at least class 3 b) test method available	a) at least class 3 b) test method available
Resistance to chemicals a) Acids and alkaline solutions with low concentration b) Acids and alkaline solutions with low concentration	10545 - 13	a) test method available b) test method available	a) Classification to be indicated by the manufacturer. b) test method available
Domestic chemicals and bath water additives (swimming pools)	10545 - 13	min. B	min. B
Emission of plumb and cadmium	10545 - 15	test method available	test method available

TERMS OF SALE, DELIVERY AND PAYMENT

Tarif from 1st January 2024 Deliveries occur exclusively under our terms of sale, delivery and payment. Differing purchasing terms of the purchaser are not acknowledged by virtue of acceptance of his order. By accepting the goods supplied by us, the purchaser declares his agreement with our terms. If one of the following terms of sale, delivery and payment becomes invalid as a result of differing legal regulations or jurisprudence, it is considered agreed that this will not affect the legal effectiveness of the remaining terms of sale, delivery and payment in their entirety.

1. **Offers** Unless described as "fixed" or "binding", our offers are provisional and do not entail any obligation to accept orders. Our offers refer to the price lists, catalogues and brochures valid when the offer is submitted.
2. **Prices** Prices are based on the price list valid on the date of delivery. We reserve the right to amend prices or add surcharges during the year if the costs of raw materials, energy or freight increase significantly on the general market.
3. **Grading** Our ceramic tiles are graded as follows: 1st grade – this corresponds to DIN EN 14411. Normal requirements in respect of perfect body, surface, cleanliness and flawless glaze can be made on 1st grade. Minor defects, slight deviations in shape and colour in individual tiles are permissible, provided that they do not impair the overall appearance when correctly laid. 2nd grade – tiles with clearly visible defects, which cannot be described as 1st grade. Compliance with DIN EN 14411 quality requirements is not a prerequisite.
4. **Identification** The quality of the tiles is identified as follows: 1st grade: Packing which contains the text "1st grade" and DIN EN 14411. Any quality different from 1st grade are identified accordingly. We don't grant any warranty for qualities different from 1st grade.
5. **Delivery times** Delivery periods or dates are only binding if confirmed by us in writing, and commence from the date of complete finalisation of the relevant order, based on our written confirmation. Substantial delays in delivery as a result of fire, manufacturing faults, strikes and other circumstances over which we have no control, will be communicated to the customer, and entitle us to an appropriate extension of the delivery time. The delivery time is considered to be fulfilled if the goods are sent before expiry of the delivery period.
6. **Default** If we are responsible for a delay or interruption in the delivery, then the purchaser can set a reasonable period of grace and, if this expires without result, withdraw from the contract. No further claims exist, particularly claims for damage compensation, subject to the regulation in Clause 12. We can declare orders with a release period to be invalid, in cases where the goods are not accepted on time and a one-week period of grace has been granted.
7. **Packing and loading** Our prices are quoted inclusive of loading costs for despatch by lorry. Our goods are loaded onto euro pallets, among other things. If the euro pallets are exchanged for the same number of intact pallets upon collection from one of our factories or upon delivery within the Federal Republic of Germany, then the euro pallets will not be invoiced. We supply large format tiles and slabs on special pallets (not euro pallets). It is not possible to exchange and/or return these special pallets. In the event of carriage-paid returns of euro pallets in perfect condition, we will credit these to the customer pro rata. The prices and the relevant credit note amount for the euro pallets will be based on the freight rate schedule valid on the date of delivery.
8. **Shipping within Germany (mainland only)** Sales are ex works; shipping is at the expense and risk of the buyer. Collection by the buyer is only possible upon express agreement. If transport insurance is required, the buyer shall bear the insurance costs. Partial deliveries are always permissible, whereby we will make every effort to ship as cheaply as possible. We are only liable for damage that can be solely attributed to improper packaging. Damage in transit must always be reported immediately to the carrier for examination, and the written record of negotiations provided for in such cases must be requested. Shipping outside of Germany (mainland) is to be regulated and agreed on an individual basis.
9. **Terms of payment** The invoice is issued on the day of dispatch and is payable no later than 30 days after the date of invoice without deduction. For payments within 8 days from the date of the invoice, we grant a 2% cash discount on the discountable amount shown. If the due date of payment is exceeded we are entitled to charge default interest. The granting of the discount requires all previous receivables to be balanced. The prerequisite for payments with acceptances or customer bills of exchange is that the payment is made within 8 days of the invoice date. The term must not exceed 3 months, acceptance is at our discretion in individual cases (discount option) and the overall discount charges are borne by the customer. Payments by cheque are only considered to be fulfilled when they are cashed. The supplier has the right to assign his claims against the purchaser (customer) to a third party. Only counterclaims that have been acknowledged by us in writing or are legally valid entitle the buyer to offset or withhold due payment. Notification of defects does not relieve the client from the timely settlement of the invoice as long as we provide the client with a bank guarantee for the claimed amount which is valid up to 14 days after the legal force of the judgment on the complaint and serves to secure the counterclaim from the complaint. If the buyer loses the legal dispute, he will bear the costs of the bank guarantee. If the above terms of payment are not adhered to, or if the payment behaviour of a buyer worsens towards us or other creditors (e.g. bill protests or lawsuits etc.), our claims will be due immediately, even if we have accepted bills of exchange or acceptances with a later due date. In this case we also reserve the right to demand advance payments even after conclusion of the supply contract.

10. Retention of title

- a) We retain ownership of all goods delivered by us, until the purchaser has paid all debts from the business relationship, particularly any current account balance. We must be notified of pledges by other creditors immediately.
- b) In the event of defaults in payment, a substantial deterioration in the purchaser's financial circumstances, the opening of judicial or extra-judicial composition proceedings or bankruptcy proceedings in respect of the purchaser's assets, we can without withdrawing from the contract, demand the return of the item, in which case the costs of return transport are borne by the purchaser. The same applies if substantiated doubts arise about the purchaser's ability or willingness to pay, after delivery.
- c) The purchaser may only resell or further process the goods subject to retention of title in proper business transactions, provided that he is not in arrears with payment; he may not pledge them to third parties, nor transfer them as security. The purchaser will assign any claims arising from processing, mixing or selling the goods supplied by us, to us with top level priority, to the amount of the sum at which our reserved goods, used for this purpose, were invoiced by the purchaser or at which they are costed in the collective invoice. The purchaser is obliged to tell us, on request, the name of the pledge creditor, as well as the above-specified amounts; at the purchaser's request we will select, by written declaration to him, from the claims thus assigned to us, those necessary to safeguard our balance; when this declaration is received by the purchaser, the assignments existing beyond this will be cancelled, with retroactive effect. If, in addition to our advance assignments in respect of the purchaser's claim against the garnishee, such assignments also exist in reference to other suppliers, with a mutually diminishing effect, then all advance assignment creditors will be entitled to the purchaser's claim against the garnishee in the proportion of their claim against the pledge creditor.
- d) The purchaser must transfer assigned claims, which have been collected by him to cover his due obligations, to us immediately, but until then must identify these objects as externally owned stock in his books and hold them in trust for us.
- e) We undertake to release – at our own option – the securities to which we are entitled in accordance with the above regulations, insofar as their realisable value exceeds the claims to be protected by 20%. With complete payment of all our claims from the business relationship, the ownership of the goods supplied by us and the claims assigned to us will pass at once to the purchaser.

11. Composition and defect claims

- a) Our tiles comply with DIN EN 14411. Deviations in size, weight, colour and the surface quality of the tiles, resulting from the special process of ceramic manufacture to the extent customary in the trade do not represent defects. Acidic and/or caustic cleaning agents can cause damage if used incorrectly. Complaints must be made about defective goods immediately after receipt of the consignment. The same applies if goods other than those ordered are delivered. We do not undertake any warranty for goods not supplied in the 1st grade.
- b) Complaints about visible defects must be made in writing immediately, and in any event before processing of the tiles. Complaints must be made about hidden defects as soon as they are discovered. Complaints that are submitted after expiry of the complaint period may be rejected by us.
- c) If goods supplied by us are defective as per a), we are obliged – at our option – under exclusion of further guarantee claims by the purchaser, to provide compensation or subsequent performance within an appropriate period of grace. If we have not provided compensation or subsequent performance within an appropriate period of grace conceded to us in writing by the customer, or if the subsequent fulfilment has been unsuccessful, then the purchaser can withdraw from the contract, under exclusion of all other claims, or request a price reduction. Purely visual defects only give an entitlement to a reduction.
- d) If a tiled surface which is the subject of a complaint is removed without our prior written agreement, we will reject all guarantee claims.
- e) Tile remnants are not taken back. We are not obliged to accept goods returned without our consent. We are entitled to send them back or store them at the sender's expense and risk.
- f) The legal limitation periods apply for claims for defects.

12. **Other liability** Any liability going beyond the above regulations as well as all other and more extensive claims, irrespective of the legal grounds (e.g. unauthorised treatment, default, failure to conclude the contract, absolute liability etc.), especially for damage compensation, are excluded. However, we will accept liability up to an amount of 25% of the order value in case of fault by our managing employees and legal representatives going beyond slight negligence, as well as for absence of expressly promised characteristics. We accept liability within the bounds of the legal requirements for claims in accordance with the product liability law and recourse claims.

13. **Foreign prices** All foreign offers and sales require our previous explicit agreement.

14. **Place of jurisdiction** German law will be applicable to the business relationship between the supplier and the purchaser (customer). The purchaser (customer) shall bear all fees, costs and expenses incurred in connection with any successful legal action against him outside Germany. Place of jurisdiction is Hamburg.

15. **Data protection** Please note that personal data belonging to our contractual partners is stored, transferred and – if necessary - amended – by us, in accordance with the Federal Data Protection Law.

PANARIAGroup Deutschland GmbH

INFORMATIONS TECHNIQUES CARREAUX DE SOL

CALIBRAGE ET RECTIFICATION

Les dimensions des carreaux de sol rectifiés sont soumises à un traitement minutieux. Grâce au processus de calibrage, la longueur et la largeur de tous les carreaux de sol sont identiques. Après la rectification, tous les carreaux de sol sont de nouveau mesurés. Les produits présentant un bombage ou ne respectant pas les tolérances dimensionnelles sont mis au rebut. Cette procédure d'ennoblissement offre deux avantages, d'une part, grâce au format précis, les carreaux de sol rectifiés peuvent être posés avec des joints à peine visibles et d'autre part, tous les carreaux de sol livrés affichent le même calibrage.

QUALITÉ DE SURFACE

Carreaux de qualité 1: Grès cérame les carreaux de sol produits par PANARIAgroup Deutschland GmbH satisfont aux exigences de la norme EN 14411 et sont conçus pour des utilisations intérieures et extérieures ainsi que pour des conditions climatiques changeantes. Si les conseils du présent catalogue concernant le domaine d'utilisation sont respectés, PANARIAgroup Deutschland GmbH garantit la résistance contre l'abrasion et l'abrasion profonde des carreaux de sol de qualité 1. La surface et les arêtes de ceux-ci sont exemptes de fissures et de défauts visibles, afin de ne pas porter atteinte à l'apparence d'une grande surface carrelée. Carreaux de qualité 2: Les carreaux de sol qui ne satisfont pas aux exigences de la classification de 1ère qualité sont déclarés comme carreaux de sol de qualité 2 et ne répondent donc pas à la norme EN 14411.

ABSORPTION D'EAU/RÉSISTANCE AU GEL

Si les carreaux de sol sont destinés à une utilisation à l'extérieur, ils doivent être résistants au gel et garantir une faible absorption d'eau. La résistance au gel est testée conformément à la norme EN 10545-12 à l'aide d'un test prédéfini de cycles de gel et de dégel. La norme d'essai EN 10545-3 réglemente en détail l'absorption d'eau. Dans ce contexte, le poids de l'échantillon sec est représenté en pourcentage par rapport au volume d'eau absorbé. Tous les produits PANARIAgroup Deutschland GmbH du présent catalogue sont classés comme résistants au gel en raison de leur faible absorption d'eau.

RÉSISTANCE À LA GLISSANCE/RÉSISTANCE CONTRE LA GLISSANCE

– DOMAINE PIEDS NUS

Les propriétés de la surface des carreaux de sol céramiques influencent sensiblement la résistance de la glissance. La résistance à la glissance est évaluée conformément à une série de normes et de méthodes prédéfinies :

DIN 51097: Détermination des propriétés antidérapantes; zones humides de circulation pieds nus.

DIN 51130: Détermination des propriétés antidérapantes; ateliers et postes de travail présentant un risque important de glissade.

Selon la norme DIN 51130, les carreaux de sol sont classés dans les groupes R9 à R13.

R9: angle d'inclinaison 6 – 10°

R10: angle d'inclinaison 10 – 19°: carreaux de sol céramiques, par ex. entrepôts, petites cuisines

R11: angle d'inclinaison 19 – 27°: carreaux de sol céramiques, par ex. cuisines, sanatoriums, installations de lavage, buanderies, ateliers de ponçage

R12: angle d'inclinaison 27 – 35°: carreaux de sol céramiques, par ex. locaux de transformation de viandes, grandes cuisines, laiteries

R13: angle d'inclinaison > 35°: carreaux de sol céramiques, par ex. abattoirs, raffineries de pétrole, tanneries.

Dans certains domaines d'activité, les exigences à la résistance contre la glissance sont particulièrement élevées. La capacité d'une surface à relief est testée quant à son aptitude à écouler ou évacuer une certaine quantité d'eau. Cette qualité est calculée selon la norme 51130. Le volume alvéolaire du relief et la dite zone d'écoulement d'eau, exprimés par la lettre «V» assortie d'un indice numérique correspondant (par ex. V4) sont déterminants.

Selon la norme DIN 51097, les carreaux de sol sont classés dans les groupes A, B et C.

Groupe A – Angle d'inclinaison 12°: zones de circulation à pieds nus (majeure partie sèche), cabines et vestiaires individuels et collectifs; sol de bassin immergé non-nageur si la profondeur de l'eau ne dépasse pas 80 cm; saunas et locaux de repos (majeure partie sèche)

Groupe B – Angle d'inclinaison 18°: zones de circulation à pieds nus (sauf ceux compris dans A); douches; aspersion de produits désinfectants; pourtour de piscines; sols de bassin immergé non-nageur quand la profondeur est partiellement inférieure à 80 cm; sol de piscine dans le domaine non-nageurs de piscines à vagues; pontons; pataugeoires; échelles conduisant dans l'eau; escaliers inférieurs à 1 mètre avec une main courante des deux côtés conduisant dans l'eau; saunas et locaux de repos (sauf ceux compris dans A)

Groupe C – Angle d'inclinaison 24°: escaliers conduisant dans l'eau (sauf ceux compris dans B); pédiluves; bordures de bassin inclinées

ABRASION

L'abrasion ou usure de la surface des carreaux de sol émaillés est indiquée par la classification PEI 1 à 5. Selon la norme d'essai EN 10545-7, l'usure est calculée grâce au test PEI effectué sous addition d'eau. L'usure peut être provoquée par la friction mécanique de grains d'oxyde d'aluminium ou de billes d'acier exécutant des mouvements rotatifs. Le nombre des rotations et l'usure de la surface visible servent de base au classement des carreaux de sol dans les groupes d'usure suivants:

Groupe d'usure I: revêtements de sol céramiques émaillés destinés à des milieux soumis à un trafic léger, sans saleté abrasive, utilisation avec des chaussures souples, par ex. habitat (salle de bain, chambres) sans accès direct de l'extérieur.

Groupe d'usure II: revêtements de sol céramiques émaillés soumis à un trafic léger et à une abrasion basse, utilisation avec des chaussures de ville, par ex. habitat privé à l'exception de la cuisine, de l'entrée et des autres pièces à trafic plus intensif.

Groupe d'usure III: revêtements de sol céramiques émaillés destinés à des milieux soumis à un trafic moyennement important avec une abrasion moyenne, utilisation avec des chaussures de ville, par ex. toutes les pièces de l'habitat privé, les balcons, les terrasses, les salles de bain d'hôtels.

Groupe d'usure IV: revêtements de sol céramiques émaillés destinés à des milieux soumis à une plus forte fréquence, utilisation avec des chaussures de ville et des salissures abrasives, par ex. entrées, magasins, restaurants, bureaux.

Groupe d'usure V: revêtements de sol céramiques émaillés conseillés dans les zones fortement fréquentées et soumises à une abrasion élevée par ex. magasins, restaurants, guichets, garages.

ABRASION PROFONDE

Les carreaux de sol non émaillés sont soumis à un test de résistance à l'abrasion profonde dont l'objectif consiste à calculer la quantité de matériau enlevée par frottement par un appareil de ponçage dans des conditions prédéfinies. Le test de résistance à l'abrasion profonde est exécuté conformément à la norme EN ISO 10545-6.

FORCE DE RUPTURE

On entend par force de rupture, la valeur limite de charge appliquée à un carreau de sol sans que celui-ci arrive à sa rupture. L'épaisseur des carreaux de sol de PANARIAgroup Deutschland GmbH est de 6 à 11 mm et n'est donc pas seulement adaptée à tous les usages (domaines résidentiels et administratifs), mais résiste aussi à des charges plus élevées.

RÉSISTANCE À LA FLEXION SELON LA NORME EN ISO 10545-4

La force de rupture (F) calculée comme charge appliquée sur 3 points est exprimée en N.

Résistance à la flexion

$$R = \frac{3 \times F \times L}{2 \times b \times h^2}$$

F = force de rupture
R = résistance à la flexion
S = force de rupture

Force de rupture

$$S = \frac{F \times L}{b}$$

b = largeur en mm
h = épaisseur en mm
L = longueur d'appui en mm

RÉSISTANCE CHIMIQUE

Les carreaux de sol PANARIAgroup Deutschland GmbH garantissent une résistance élevée contre les produits chimiques, les acides, les bases et les agents tachants qui est contrôlée dans le cadre du processus de contrôle prescrit:

Résistance chimique selon la norme EN ISO 10545-13

Solutions aqueuses testées

- produit chimique domestique:
sel ammoniac 100g/l;
- adjuvants d'eau de baignade (piscines):
solution d'hypochlorite de sodium 20g/l

Classes

- non-émaillé: A/B/C*
- émaillé: A/B/C*

Acides et bases

- Concentration faible (L)
 - a) solution chlorhydrique 3%
 - b) solution d'acide citrique 100g/l
 - c) solution d'hydrate de potassium 30g/l

- Concentration élevée (H)
 - a) solution chlorhydrique 18%
 - b) solution d'acide lactique 5%
 - c) solution d'hydrate de potassium 100g/l

Classes

- non-émaillé: LA/LB/LC ou HA/HB/HC*
- émaillé: LA/LB/LC ou HA/HB/HC*
- * classe A résistance la plus élevée, ordre décroissant jusqu'à la classe C

Résistance aux taches selon EN ISO 10545-14

Agents tachants

- solutions tachantes; colorants verts dans l'huile; colorants rouges dans l'huile; colorants chimiques; iode, 13g/l dans de l'alcool; agents tachant formant un film; huile l'olive

Nettoyage

- produits de nettoyage : eau chaude (+55°C), détergents doux, détergents forts
- solvants: solution chlorhydrique 3%; hydrate de potassium 200g/l; acétone

Classes: 5/4/3/2/1*

- * La classe 5 affiche la résistance aux taches la plus élevée, allant dans l'ordre décroissant jusqu'à la classe 1.

Dégagement de plomb et de cadmium

Les surfaces émaillées sont exposées à une solution à l'acide acétique. Ensuite, la quantité de plomb et de cadmium dégagée est déterminée.

NETTOYAGE DES SOLS EN CÉRAMIQUE

Lors du nettoyage des revêtements de sol en céramique, il convient de différencier entre un premier nettoyage ou un nettoyage en profondeur et le nettoyage courant:

1. Premier nettoyage ou nettoyage en profondeur

Un premier nettoyage ou nettoyage en profondeur est effectué à la fin des travaux de pose et fait partie des tâches du poseur. Ce nettoyage élimine les résidus des travaux de pose (excédent des produits de jointoiement et de scellement, résidus du chantier) ainsi que les traces sur les surfaces posées. Très souvent, les problèmes de nettoyage postérieurs sont dus à des nettoyages en profondeur défectueux ou manquants. Nous recommandons les produits de nettoyage utilisés par le poseur de carrelage, spécialement développés à cette fin. Il faut absolument tester la résistance des surfaces à nettoyer avant toute utilisation de produit de nettoyage et respecter les indications du fabricant du produit de nettoyage.

2. Nettoyage courant

Les liquides contenant des pigments de couleur, des huiles et des graisses peuvent tacher les sols de céramique non vitrifiés. Pour prévenir cela, l'utilisation d'un agent d'imperméabilisation courant, vendu dans le commerce, est recommandée. Le poseur du carrelage devrait procéder au traitement adéquat du revêtement après le nettoyage en profondeur et avant sa mise en service. Il est conseillé d'utiliser de l'eau pour le nettoyage courant du carrelage des salissures dues au passage. Il faut proscrire, dans tous les cas, l'utilisation de produits de nettoyage contenant des agents d'imprégnation ou nourrissants.

POSE

Pour la pose de carreaux de grès cérame de grand format, il est recommandé d'utiliser la colle C2 S1 ou C2 S2, selon le support et le produit.

FROTTEMENT DE GLISSEMENT

Interlocuteur : Deutsche Gesetzliche Unfallversicherung,
Mittelstraße 51, 10117 Berlin-Mitte,
téléphone : +49 - 30 - 2 88 76 - 38 00, Fax : - 3808,
www.dguv.de, info@dguv.de, www.unfallkassen.de.

Norme de contrôle: DIN 51131. Fiche : Fiche d'information DGUV 208-041 « Évaluation du risque de glissade en conditions d'utilisation » (anciennement GUV-I 8687). Ce contrôle n'est pas un examen de type et ne peut donc servir de base au choix des revêtements de sol à l'étape de la planification, ni à l'affectation à une catégorie d'évaluation de l'effet antidérapant. Ce procédé peut par exemple servir à évaluer le succès de mesures de nettoyage ou lors de la planification d'un changement d'utilisation.

Concernant le choix du revêtement de sol, il convient d'appliquer exclusivement la règle DGUV 108-003 (anciennement BGR 181) ou la fiche d'information DGUV 207-006 (anciennement GUV-I 8527)!

ZONES À USAGE PRIVÉ

Concernant la sécurité à pied, les revêtements de sol céramique ne sont soumis à aucune réglementation lorsqu'il s'agit d'un usage privé. Il est toutefois recommandé de choisir des carrelages antidérapants, en fonction des exigences de sécurité personnelles.

SÉCURITÉ À PIED SUR SOL GLISSANT

Base légale: L'ordonnance relative aux lieux de travail, tout comme les règles relatives à la prévention des accidents, imposent que les sols soient plans, antidérapants et faciles à nettoyer. Les « règles techniques relatives aux lieux de travail » comportent les exigences détaillées ASR. A 1.5/1,2 « Sols » Éditeur: Institut fédéral pour la sécurité et la médecine du travail (commission des lieux de travail).

Source: Téléchargement sous www.baua.de

BORDURE ANTIQUE

La bordure antique se caractérise par un bord irrégulier aposé sur un chant rectifié. C'est un modèle hybride qui combine les atouts d'un hant moulé de style naturel ou rustique avec ceux d'un chant rectifié.



EN 14411

Les exigences concernant les dimensions et la qualité de surface ainsi que les caractéristiques.

Dimensions et qualité de surface	Norm d'essai ISO	Groupe BIII	Groupe BIA
		Carreaux et dalles céramiques comprimés à sec E > 10%; N ≥ 15 cm	Carreaux et dalles céramiques comprimés à sec à faible absorption d'eau E ≤ 0,5%
			Surface S [en cm ²] > 410
Longueur et largeur [écart en %]	10545 - 2	± 0,5 % / ± 0,2 mm	± 0,6 % / ± 2,0 mm
Épaisseur [écart en % de l'épaisseur spécifié du fabricant]	10545 - 2	± 10 % / ± 0,5 mm	± 5,0 % / ± 0,5 mm
Alignement des arêtes (face de vue) [écart maximal en % relatif à la taille d'usine]	10545 - 2	± 0,3 % / ± 1,5 mm	± 0,5 % / ± 1,5 mm
Orthogonalité [écart maximal en % relatif à la taille d'usine]	10545 - 2	± 0,5 % / ± 2,0 mm	± 0,5 % / ± 2,0 mm
Planéité [écart en %]	10545 - 2		
a) Courbure centrée de la diagonale		a) + 0,5 % / + 2,0 mm - 0,3 % / - 1,5 mm	a) ± 0,5 % / ± 2,0 mm
b) Courbure de l'arête		b) + 0,5 % / + 2,0 mm - 0,3 % / - 1,5 mm	a) ± 0,5 % / ± 2,0 mm
c) Diagonale gauchie		c) ± 0,5 % / ± 2,0 mm	a) ± 0,5 % / ± 2,0 mm
Qualité de surface	10545 - 2	Au moins 95% des carreaux et dalles doivent être exempts de fautes visibles qui pourraient affecter l'apparence d'une zone considérable de carreaux.	Au moins 95% des carreaux et dalles doivent être exempts de fautes visibles qui pourraient affecter l'apparence d'une zone considérable de carreaux.
Caractéristiques physiques			
Absorption d'eau [en % de poids]	10545 - 3	Absorption d'eau comprise entre 10% et 20%	< 0,5% Valeur isolée maximale 0,6%
Charge de rupture [en N]	10545 - 4		
a) Épaisseur ≥ 7,5 mm		a) min. 600	a) min. 1.300
b) Épaisseur < 7,5 mm		b) min. 200	b) min. 700
Résistance à la flexion [en N/mm ²]	10545 - 4		
a) Épaisseur ≥ 7,5 mm		a) min. 12	a) min. 35
b) Épaisseur < 7,5 mm		b) min. valeur isolée 15	b) min. valeur isolée 32
Résistance à l'abrasion			
a) de carreaux non émaillés et dalles: perte de volume	10545 - 6	a) -	a) max. 175 mm ³
b) des carreaux et dalles vernis pour la production de revêtements du sol	10545 - 7	b) Catégorie d'usure et nombre des cycles de meulage à indiquer.	b) Catégorie d'usure et nombre des cycles de meulage à indiquer.
Coefficient de dilatation thermique linéique [de la température ambiante à 100°C]	10545 - 8	Méthode d'essai existant	Méthode d'essai existant
Résistance aux chocs thermiques	10545 - 9	Méthode d'essai existant	Méthode d'essai existant
Résistance au tréaillage	10545 - 11	exigé	exigé
Résistance au gel	10545 - 12	Méthode d'essai existant	exigé
Coefficient de friction (carreaux et dalles pour la production de revêtements du sol)	Indiquer méthode d'essai	en cas d'exigence	en cas d'exigence
Allongement à l'humidité [en mm/m]	10545 - 10	Méthode d'essai existant	Méthode d'essai existant
Différences mineures en couleur	10545 - 16	Méthode d'essai existant	Méthode d'essai existant
Résistance aux chocs	10545 - 5	Méthode d'essai existant	Méthode d'essai existant
Caractéristiques chimiques			
Résistance aux taches	10545 - 14		
a) Carreaux et dalles émaillés		a) au moins classe 3	a) au moins classe 3
b) Carreaux et dalles non émaillés		b) Méthode d'essai existant	b) Méthode d'essai existant
Résistance aux produits chimiques	10545 - 13		
a) Acides et lessives alcalines à faible concentration		a) Méthode d'essai existant	a) La catégorie doit être indiquée par le fabricant.
b) Acides et lessives alcalines à forte concentration		b) Méthode d'essai existant	b) Méthode d'essai existant
Produits chimiques domestiques et ajouts à l'eau de bain (piscine)	10545 - 13	min. B	min. B
Émission de plomb et de cadmium	10545 - 15	Méthode d'essai existant	Méthode d'essai existant

CONDITIONS DE VENTE, DE LIVRAISON ET DE PAIEMENT

Tarif du 1. janvier 2024 Les livraisons s'effectuent exclusivement conformément à nos conditions de vente, de livraison et de paiement, à l'exclusion de toutes les autres conditions du client qui ne seront pas reconnues, en vertu de l'acceptation de sa commande. En acceptant les marchandises que nous lui livrons, l'acheteur déclare accepter nos conditions. Si une de nos conditions de vente, de livraison ou de paiement était entachée de nullité à la suite d'une réglementation judiciaire divergente ou d'une jurisprudence divergente, la validité juridique des autres conditions de vente, de livraison et de paiement n'en serait pas affectée.

- 1. Offres** Nos offres sont sans engagement, sauf si elles sont qualifiées de «fixes» ou «fermes», et ne nous obligent pas à accepter la commande. Nos offres se rapportent aux listes de prix, catalogues et prospectus en vigueur au moment de la remise de l'offre.
- 2. Prix** Les prix facturés correspondent au tarif valable au jour de la livraison. Nous nous réservons le droit de procéder en cours d'année à des adaptations ou majorations des prix, en cas de nette augmentation des prix généraux du marché pour les matières premières, l'énergie ou le transport.
- 3. Classement** Nos carrelages céramiques sont classés comme suit: 1er choix: il correspond à la norme DIN EN 14411. Le 1er choix satisfait aux exigences normales relatives à une pâte sans défaut, à la surface, à la propreté et à la beauté de l'émail. De petits défauts, de légères différences au niveau de la forme et de la couleur des carrelages individuels sont acceptables, pour autant qu'ils n'affectent pas l'aspect global lorsque le carrelage est posé selon les règles de l'art. 2ème choix – carrelages présentant des défauts clairement identifiables, ne pouvant être définis comme étant de 1er choix. La conformité aux exigences de qualité conformément à la norme DIN EN 14411 n'est pas une condition.
- 4. Identification** La qualité des carrelages est identifiée comme suit: 1er choix: emballage indiquant la mention « 1er choix » et DIN EN 14411. Les autres niveaux de qualité sont indiqués de façon correspondante. Nous n'accordons pas de garantie sur la marchandise n'étant pas de 1er choix.
- 5. Délais de livraison** Les délais ou dates de livraison ne nous engagent que lorsqu'ils font l'objet d'une confirmation écrite, et commencent à courir à partir du jour de l'élaboration définitive de la commande concernée, sur la base de l'envoi de notre confirmation écrite. Des retards de livraison considérables survenus à la suite d'un incendie, de problèmes de fabrication, d'une grève ou de circonstances assimilées, sur lesquelles nous ne pouvons influencer, seront communiqués au client et nous autorisent à prolonger le délai de livraison en conséquence. Le délai de livraison sera réputé respecté lorsque l'expédition des marchandises intervient avant l'expiration du délai de livraison.
- 6. Retard** Si nous sommes responsables d'un retard ou d'une interruption de la livraison, l'acheteur pourra fixer un délai supplémentaire adapté, et si la livraison n'a pas été effectuée à l'expiration de ce nouveau délai, il sera en droit de mettre fin au contrat. Le client ne peut faire valoir d'autres prétentions, en particulier le droit à des dommages et intérêts, sous réserve des dispositions reprises au point 12. En cas d'enlèvement tardif des marchandises, les commandes avec livraison sur appel pourront être considérées comme nulles à l'issue de l'octroi d'un délai supplémentaire d'une semaine.
- 7. Conditionnement et chargement** Nos prix s'entendent frais de chargement pour le transport routier compris. Notre marchandise est entre autres chargée sur EURO-palettes. Nous facturons 12,50 € par palette. En cas de livraisons au sein de la République Fédérale d'Allemagne, elles ne feront pas l'objet d'une facturation sous réserve que le même nombre de palettes échangeables intactes soit restitué. Si les palettes sont retournées franco de port et en parfait état, nous créditerons un montant de 9,00 €. Si nous effectuons la livraison sur des palettes spéciales (pas de palettes Euro), par exemple dans le cas de grands formats, nous facturons un forfait d'emballage de 42,00 € par palette. L'échange ou le retour de ces palettes spéciales est exclu. La livraison des articles au format géant 120 x 260 cm s'effectue à l'aide de boîtes de transport spécialement conçues à cet effet, facturées 100,00 € pièce.
- 8. Expédition en Allemagne (uniquement continent)** Les ventes ont lieu départ usine, l'expédition s'effectue aux frais et aux risques de l'acheteur. Le retrait par l'acheteur n'est possible que sur accord exprès. Si une assurance transport est souhaitée, l'acheteur doit en assumer les frais. Les livraisons partielles sont autorisées à tout moment; nous nous efforçons néanmoins d'assurer les expéditions dans les conditions les plus avantageuses possibles. Notre responsabilité n'est engagée que pour les dommages imputables exclusivement à un emballage non conforme. Les dommages de transport devront toujours être déclarés à l'entreprise de transport pour examen, un procès-verbal de déclaration prévu pour ces cas doit être exigé. L'expédition hors d'Allemagne (continent) est réglée et convenue de manière individuelle.
- 9. Conditions de paiement** La facture est établie le jour de l'expédition et payable, sans déduction, au plus tard 30 jours après la date de facturation. Pour les paiements effectués dans les 8 jours à compter de la date de facturation, nous accordons un escompte de 2% sur le montant indiqué pouvant être soumis à escompte. En cas de dépassement de l'échéance, nous serons en droit de facturer des intérêts de retard. Le droit à déduction de l'escompte est soumis à la condition que toutes les créances échues aient été réglées. Les paiements par traites ou lettres de change doivent intervenir dans les 8 jours suivant la date de facturation. La durée ne doit pas excéder 3 mois, nous nous réservons le droit d'étudier l'acceptation au cas par cas (possibilité d'escompte) et la totalité des frais d'escompte sont à la charge du client. Le fournisseur a le droit de céder ses créances contre l'acheteur (le client) à un tiers. Les chèques ne valent paiement qu'au moment de leur encaissement. Seules les contre-prétentions reconnues par écrit par nos soins ou exécutoires de par la loi confèrent à l'acheteur le droit de compenser ou de retenir des créances échues. Les réclamations pour vices n'exonèrent pas le mandant du règlement à l'échéance de la facture, dans la mesure où nous lui fournissons une caution bancaire portant sur le montant contesté, valable jusqu'à 14 jours après l'entrée en force du jugement relatif à la réclamation pour vices et destinée à garantir la contre-prétention en résultant. Si l'acheteur perd le procès, il sera tenu d'assumer les frais relatifs à la caution bancaire. Si les conditions de paiement précitées ne sont pas respectées ou si les modalités de paiement d'un acquéreur se détériorent à notre égard ou à l'égard d'un autre créancier (p. ex. protêts ou actions en justice et similaires), nos créances deviendront immédiatement exigibles, et ce même si nous avons accepté des lettres de change ou des acceptations à échéance plus tardive. De plus, dans ce cas, nous nous réservons le droit de demander des acomptes même après la conclusion du contrat de livraison.

10. Réserve de propriété

- a) Nous nous réservons la propriété de l'ensemble des marchandises que nous avons livrées, jusqu'au paiement intégral de toutes les créances découlant de transaction commerciale, en particulier le paiement d'un éventuel solde en compte courant. Les saisies effectuées par un autre créancier doivent nous être communiquées sans délai.
- b) En cas de retard de paiement, de détérioration sensible de la santé financière du client, d'ouverture d'une procédure concordataire judiciaire ou extra judiciaire ou en cas d'ouverture d'une faillite sur le patrimoine du client, nous pourrions exiger la restitution de la marchandise, sans mettre fin au contrat, les frais de réexpédition étant à la charge de l'acheteur. Le même principe s'applique si nous avons des doutes fondés sur la solvabilité ou la disposition du client à payer après la livraison.
- c) L'acheteur est autorisé à revendre ou à transformer les marchandises faisant l'objet de la réserve de propriété uniquement dans le cadre de son exploitation commerciale habituelle, pour autant qu'il n'accuse pas de retard de paiement. Il n'est pas autorisé à les donner en nantissement à un tiers, ni à les lui transférer en garantie. L'acheteur nous cédera en priorité et sans délai les droits découlant du traitement/de la modification, de l'incorporation/de l'intégration ou de la cession des marchandises que nous avons livrées, à concurrence du montant porté en compte pour la marchandise faisant l'objet de la réserve de propriété ou calculé dans une facture globale. A notre demande, l'acheteur est tenu de nous communiquer le nom des tiers débiteurs, de même que les montants spécifiés ci-dessus. A la demande de l'acheteur, nous choisirons parmi les créances qu'il nous a cédées celles qui sont nécessaires pour garantir notre solde et l'en informerons par écrit. A la réception de cette communication par le client, les autres cessions existantes seront annulées avec effet rétroactif. Concernant la créance de l'acheteur à l'égard du tiers débiteur, si outre nos cessions anticipées, d'autres créances existent en faveur d'autres fournisseurs, et qu'elles s'amoindrissent mutuellement, la créance de l'acheteur à l'égard du tiers débiteur reviendra à tous les créanciers cessionnaires à concurrence de leur créance à l'égard du tiers débiteur.
- d) L'acheteur doit nous transférer immédiatement les créances cédées, qu'il a recouvrées pour garantir ses obligations échues jusque là, il est tenu de les définir comme appartenant à un tiers et de les conserver à titre fiduciaire dans ses livres.
- e) Nous nous engageons à libérer les garanties mises à notre disposition conformément aux dispositions susmentionnées, à notre appréciation, dans la mesure où leur valeur réalisable dépasse le total des créances à garantir de 20%. La propriété des marchandises livrées et des créances qui nous ont été cédées sera transférée au client après le paiement intégral de toutes nos créances découlant de la transaction commerciale.

11. Qualité et réclamations pour défaut.

- a) Nos carrelages satisfont aux caractéristiques de la norme DIN EN 14411. En raison de la particularité de la fabrication céramique, les divergences en termes de dimensions, de poids, de nuance et de qualité de la surface des carrelages, qui se rencontrent à une fréquence habituelle dans ce secteur, ne constituent pas un défaut. Des détergents acides et/ou corrosifs peuvent provoquer des dégâts en cas d'utilisation non conforme. Les marchandises manquantes doivent être réclamées directement après la réception de l'envoi. Le même principe s'applique lorsque les marchandises livrées diffèrent des marchandises qui ont été commandées. Nous n'octroyons pas de garantie pour les marchandises ne faisant pas partie du premier choix.
- b) Les défauts apparents doivent faire l'objet d'une réclamation écrite dans les meilleurs délais, et dans tous les cas avant la transformation des carrelages. Les réclamations concernant les défauts cachés doivent être introduites dès que ceux-ci sont décelés. Nous sommes en droit de réfuter toute réclamation introduite après l'expiration du délai de réclamation.
- c) Si les marchandises que nous vous avons livrées présentent un défaut conformément au point a), nous sommes tenus, à l'exclusion de tout autre droit à la garantie du client, de fournir une marchandise en remplacement ou de procéder à une nouvelle livraison, dans un délai raisonnable, à notre appréciation. Si nous n'avons pas fourni une marchandise en remplacement ni effectué de nouvelle livraison dans un délai raisonnable, communiqué par écrit au client, ou en cas d'échec de la nouvelle livraison, le client pourra mettre fin au contrat, à l'exclusion de tout autre droit, ou pourra exiger une réduction du prix. Des défauts purement visuels donnent uniquement droit à une réduction.
- d) Nous déclinons toute garantie en cas d'enlèvement d'un revêtement en carrelages faisant l'objet d'une réclamation sans notre autorisation écrite préalable.
- e) Les restes de carrelages ne sont pas repris. Nous ne sommes pas obligés de reprendre des marchandises qui nous sont retournées sans notre autorisation. Nous sommes autorisés à renvoyer ou à entreposer ces marchandises aux frais et aux risques de l'expéditeur.
- f) Les délais de prescription légaux pour les réclamations concernant les défauts sont d'application.

12. Limitation de responsabilité Toute responsabilité et toute autre prétention dépassant le cadre des dispositions susmentionnées sont exclues, quel que soit leur motif juridique (par ex. acte non autorisé, retard, responsabilité en cas de cessation de contrat, responsabilité inhérente au risque créé, etc.), en particulier les prétentions à dommages et intérêts. Toutefois, en ce qui concerne la responsabilité de nos cadres et de nos représentants légaux pour une faute dépassant la négligence simple, ainsi que pour l'absence de caractéristiques expressément garanties, nous assumons une responsabilité à concurrence de 25% du montant du contrat. En ce qui concerne les prétentions conformément à la loi sur la responsabilité des produits et les droits de recours dans le cadre de l'achat d'un bien de consommation, notre responsabilité est engagée conformément aux dispositions légales.

13. Prix pour l'étranger Toutes les offres et toutes les ventes à l'étranger doivent toujours faire l'objet d'un accord préalable particulier.

14. Tribunal compétent Pour la relation commerciale entre le fournisseur et l'acheteur (client), le droit allemand s'applique. L'acheteur (client) supporte tous les frais, coûts et dépenses engagés dans le cadre de toute action en justice réussie légalement contre lui en dehors de l'Allemagne. Tribunal compétent est Hamburg.

15. Protection des données Veuillez noter que les données personnelles de nos partenaires commerciaux sont enregistrées, transmises et, si nécessaire, modifiées conformément à la loi fédérale sur la protection des données.

PANARIAGroup Deutschland GmbH

Kerastraße 1
04703 Leisnig

T. +49 34321 663-0
F. +49 34321 663-50

info@panariagroup.de
www.panariagroup.de

PANARIAgroup®
Deutschland GmbH

Diesen Katalog gestaltete die PANARIAGroup Deutschland GmbH nach bestem Wissen und Gewissen. Aus rechtlichen Gründen behält sich das Unternehmen das Recht vor, die Angaben im Katalog ohne vorherige Ankündigung zu ändern. Forderungen aufgrund eines daraus direkt oder indirekt entstandenen Schadens können daher nicht anerkannt werden.



PANARIAGroup Deutschland GmbH produced this catalogue according to best knowledge and belief. For legal reasons, the company reserves the right to change the statements in the catalogue without prior notice. Thus we shall not accept responsibility for claims due to damage resulting directly or indirectly from this.

PANARIAGroup Deutschland GmbH a conçu ce catalogue avec le plus grand soin. Pour des raisons juridiques, l'entreprise se réserve le droit de modifier les données du catalogue sans avis préalable. Les réclamations consécutives à l'apparition d'un dommage direct ou indirect seront par conséquent irrecevables.

ZEICHENERKLÄRUNG

EXPLANATION OF SYMBOLS

LÉGENDE



Frostbeständigkeit
Frost-resistance
Résistance au gel



Durchgefärbtes Feinsteinzeug
Porcelain gres solid-coloured
Grès cérame coloré



Rektifiziert
Rectified
Rectifié



Fliesenstärke
Tile thickness
Épaisseur du carrelage



Rutschhemmung
Slip-resistance
Sécurité de déambulation



Barfuss-Klassifikation
Barefeed classification
Pieds nus classification



Abriebgruppe
Abrasion
Résistance



Vielfalt des Farbspiels der Grundfliese
Colour interplay of plain tile
Diversité du jeu de lumière



Keine kostenlose Bemusterung
Samples will be invoiced
Echantillons seront facturés



Dekorelement mit Edelmetallaufgabe
Decors with precious metal application
Décors avec application de métaux précieux



Achtung - verschiedene Maserungen
Attention - different texture
Attention - grains de bois différents



Set-Element. Zur Vervollständigung des Sets bitte
Ergänzungselement(e) mitbestellen
Piece of set. Complementary pieces to be ordered separately
Composition partielle. Pièces complémentaires à commander



Auftragsfertigung - bitte Lieferzeit beachten
Commissioned production - please notice delivery time
Production sur commande - veuillez noter le délai de livraison



Auch als KERBON erhältlich
Also available as KERBON
Également disponible en KERBON



Grundfliese
Plain tile
Uni



Mosaik, netzverklebt
Mosaic, glued on mesh-type net
Mosaïque, collé sur maillage



Dekor
Decor
Décor



Flächendekor
Decorated plain tile
Uni décoré



Bordüre
Border
Bordure



Sockel*
Plinth*
Plinthe*



Stufe
Steps
Marche



Verpackungsinhalt
Packaging units
Contenu de l'emballage



Format
Format
Format

*Sockel gerade geschnitten, beide Kanten gefast



PANARIAgroup®
Deutschland GmbH



PANARIAGroup Deutschland GmbH

Kerastraße 1
04703 Leisnig

info@panariagroup.de
www.panariagroup.de